

CIRCULUS



1 2 3 4 5 6 7 8 9 10 11 12 13 14 15 16

NIVEAU 1 NIVEAU 2 NIVEAU 3 NIVEAU 4

CIRCULUS

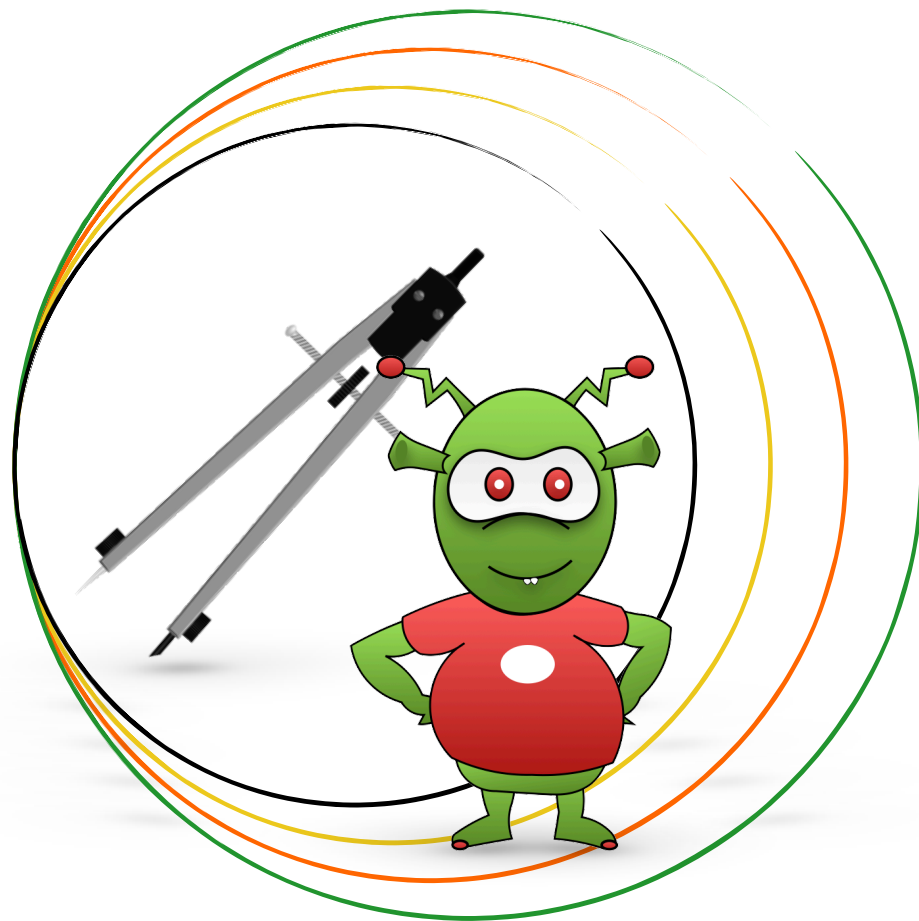

1 2 3 4 5 6 7 8 9 10 11 12 13 14 15 16

NIVEAU 1 NIVEAU 2 NIVEAU 3 NIVEAU 4

CIRCULUS

1

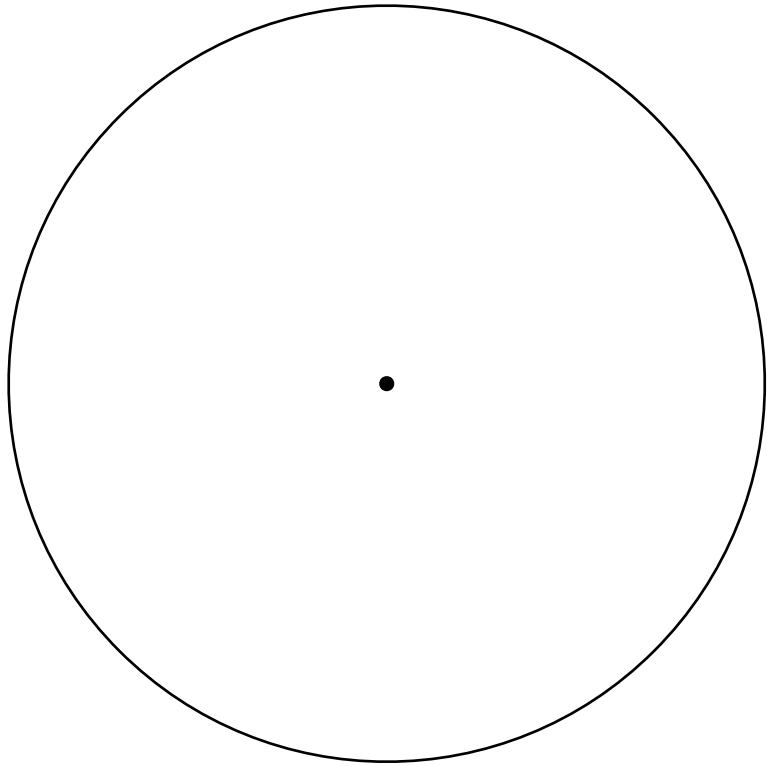

CIRCULUS

1

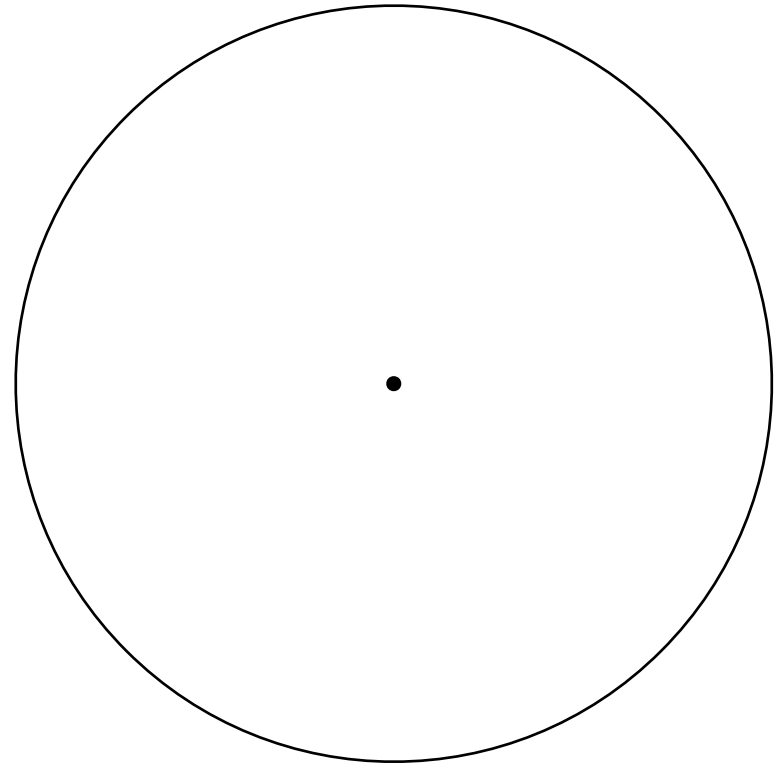

CIRCULUS

2

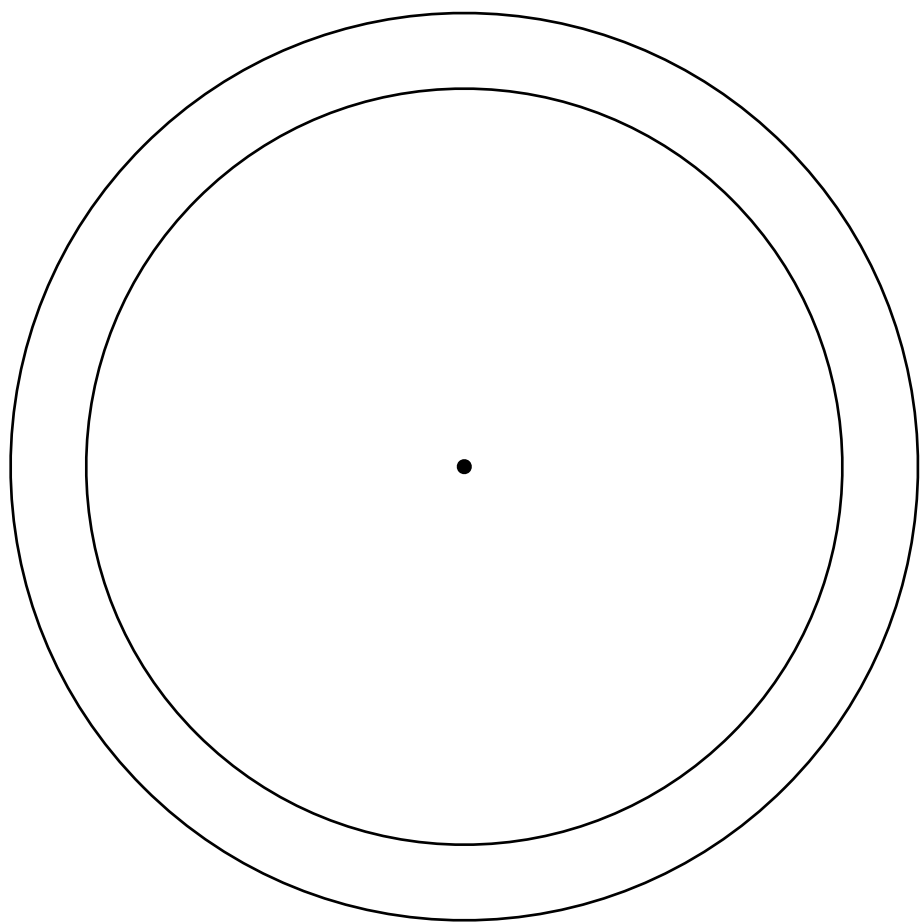

CIRCULUS

2

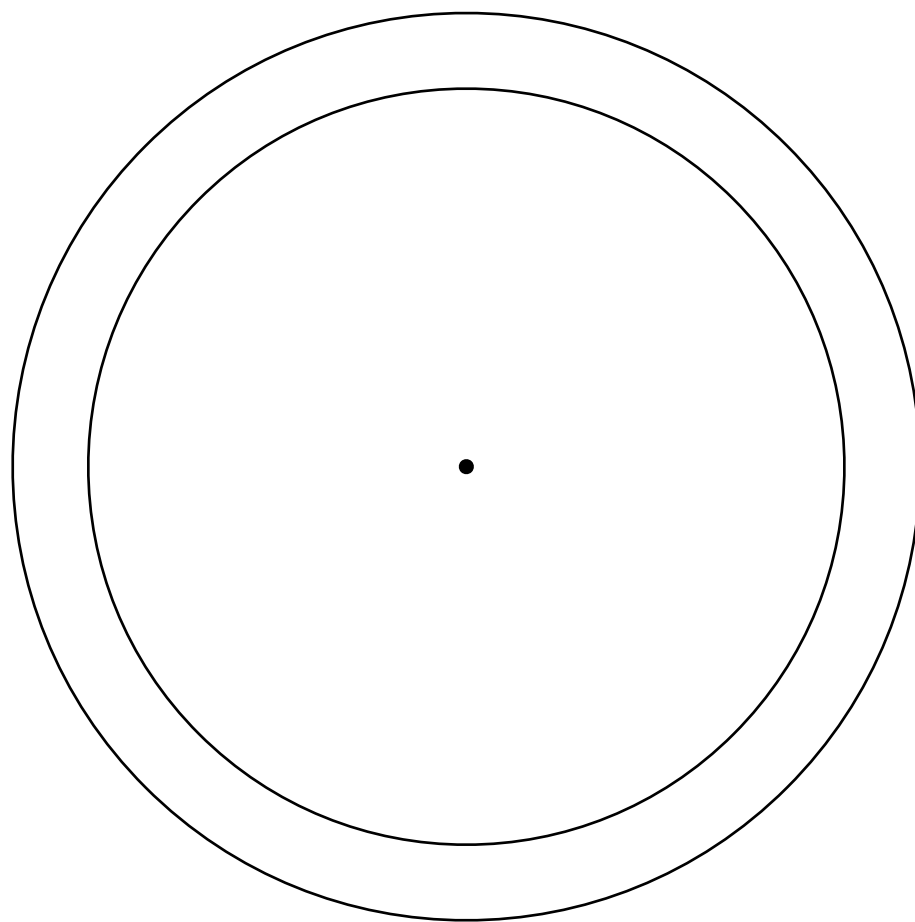

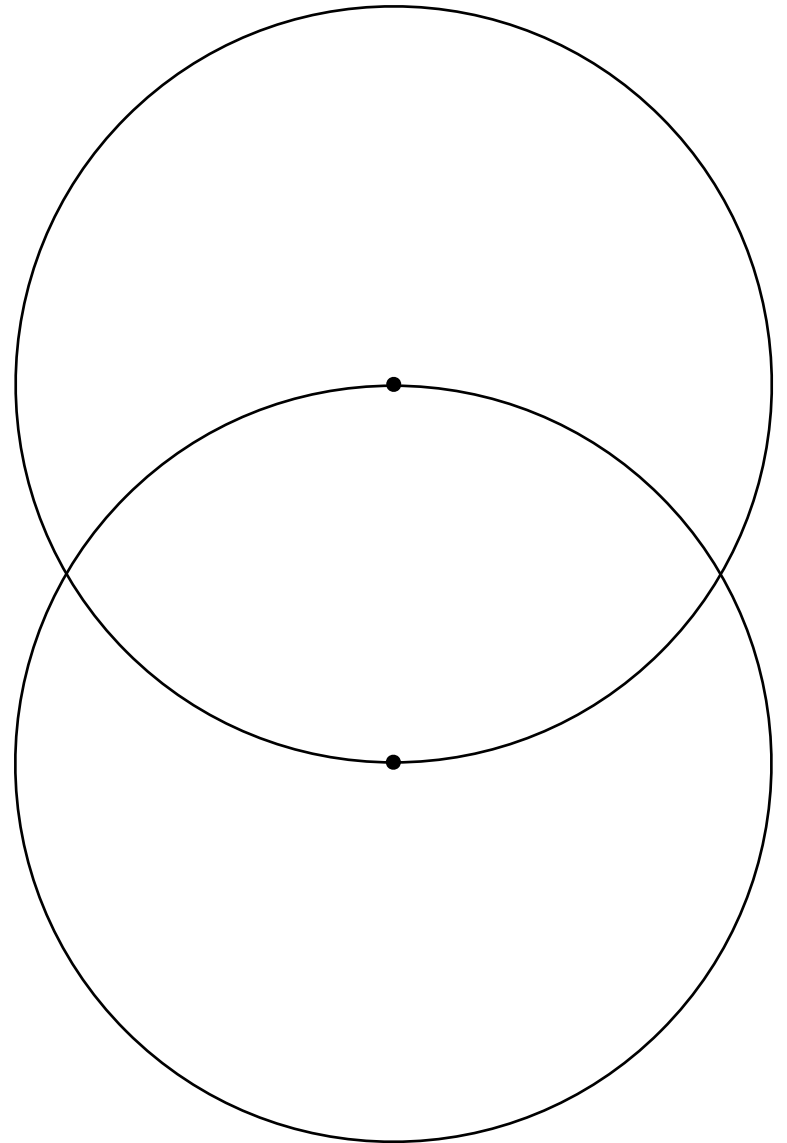
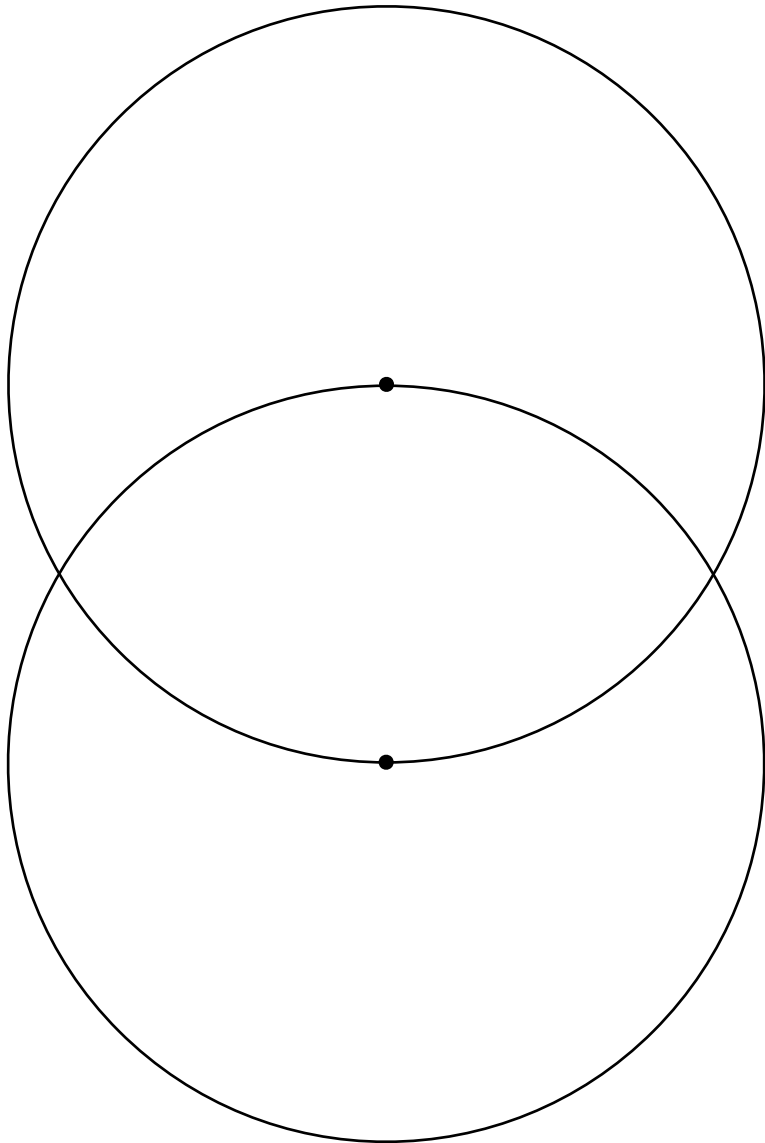

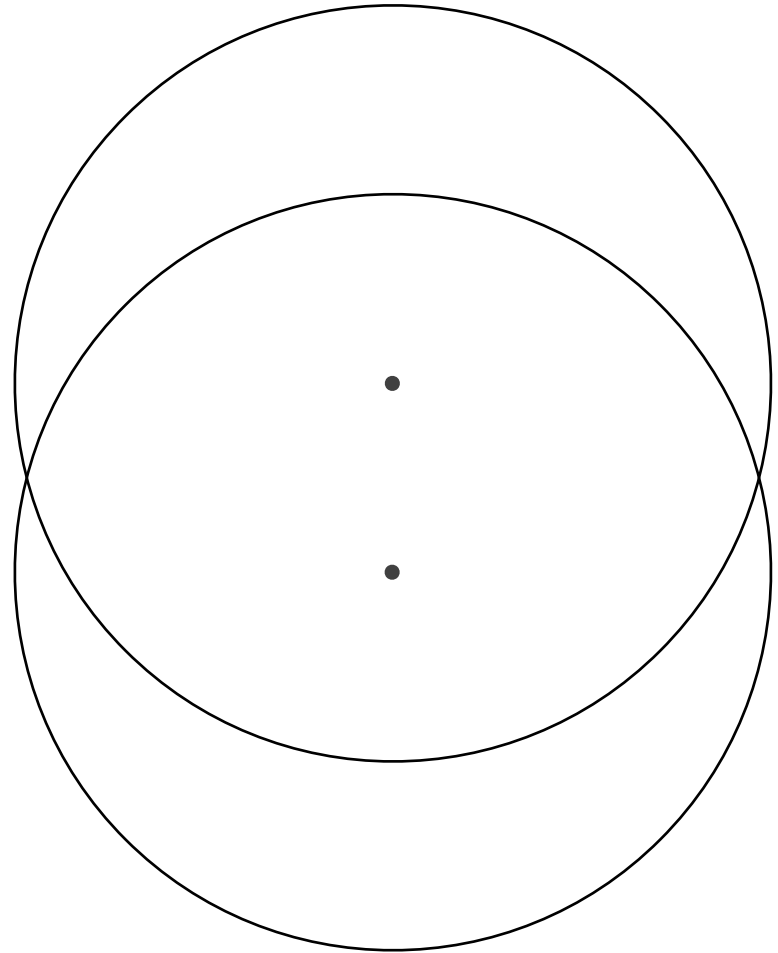
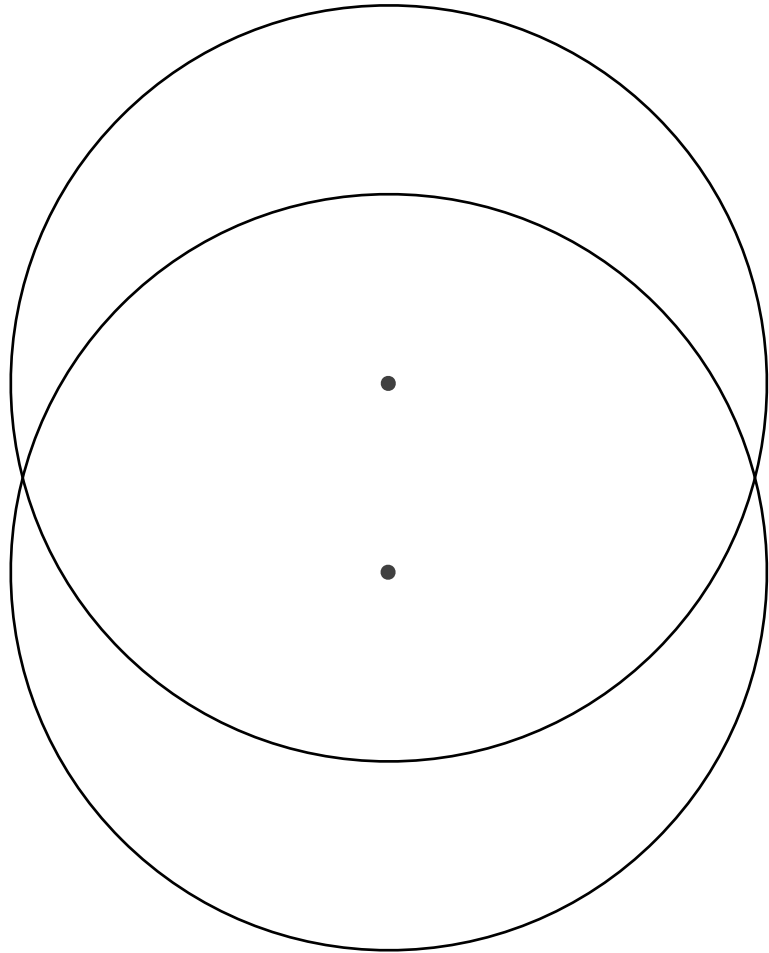

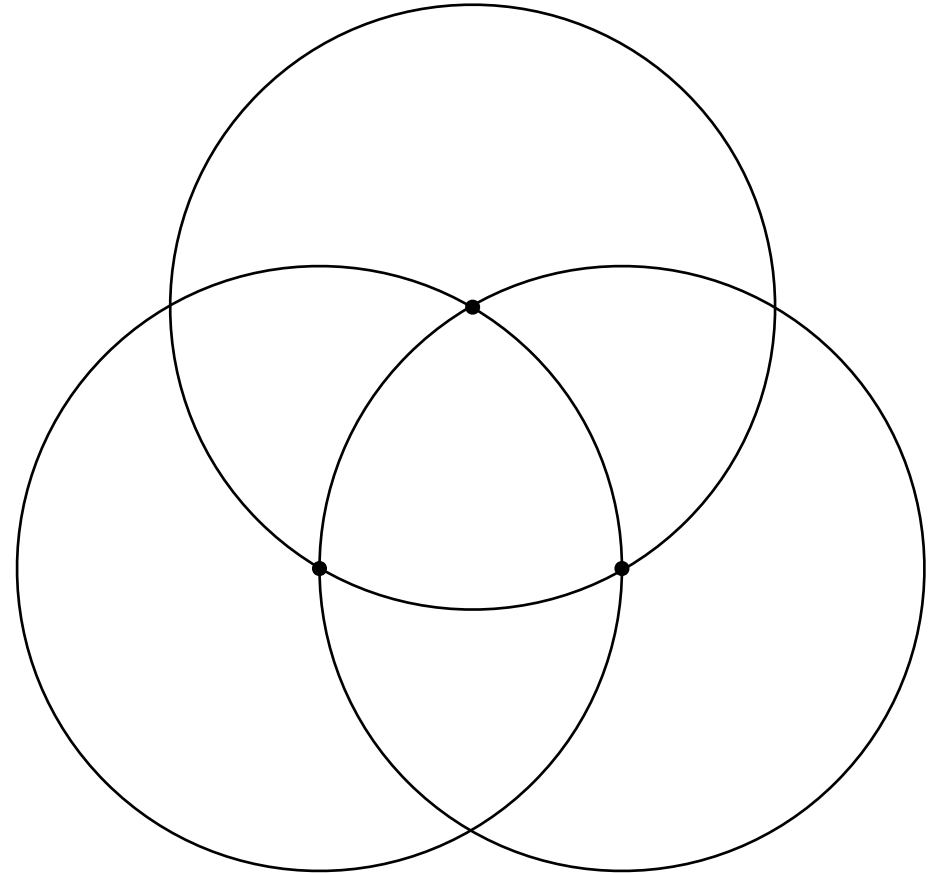
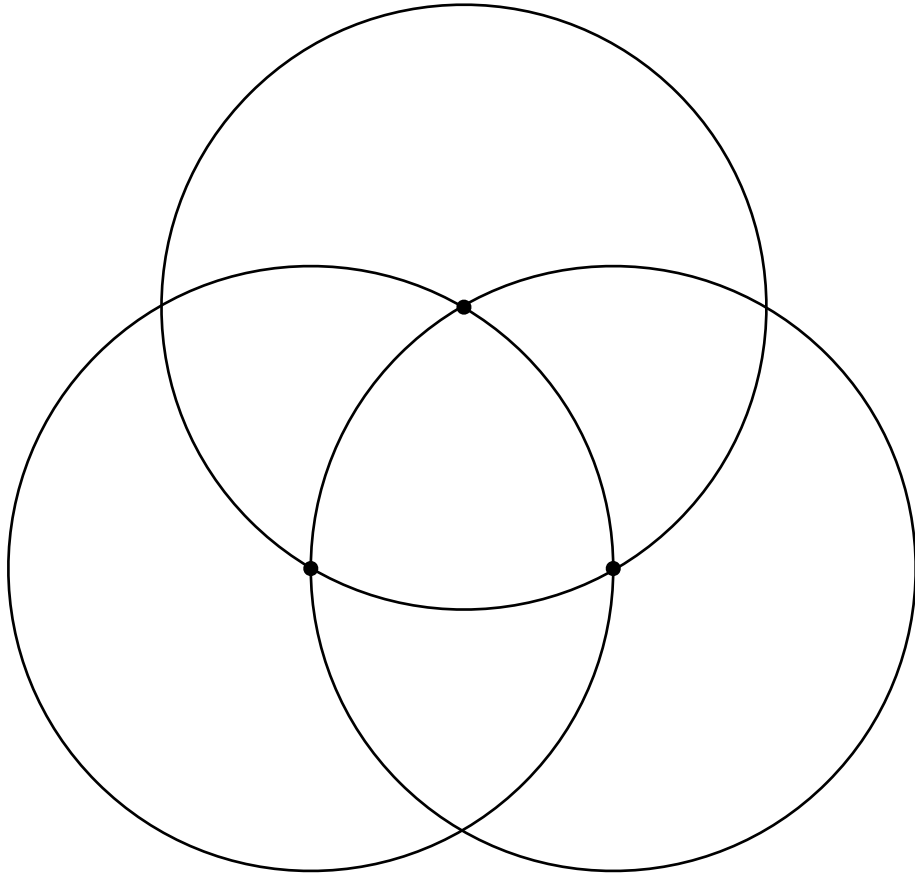

CIRCULUS

6

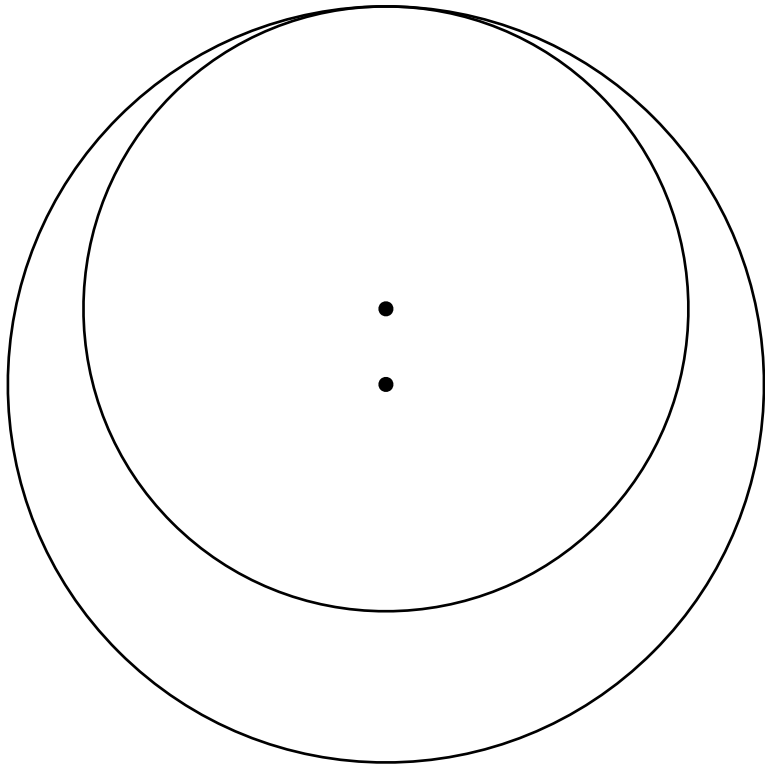

CIRCULUS

6

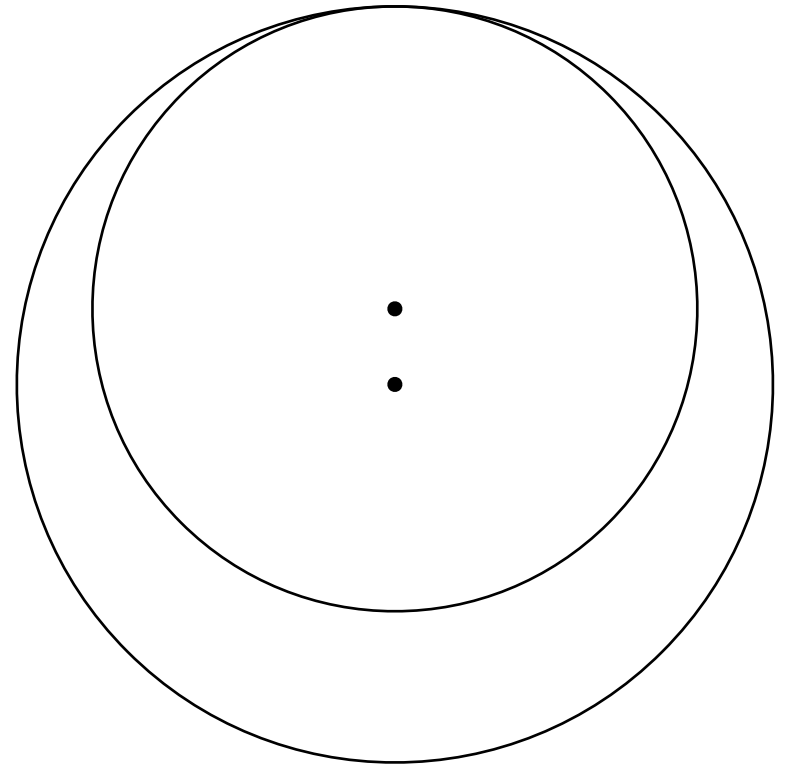

CIRCULUS

7

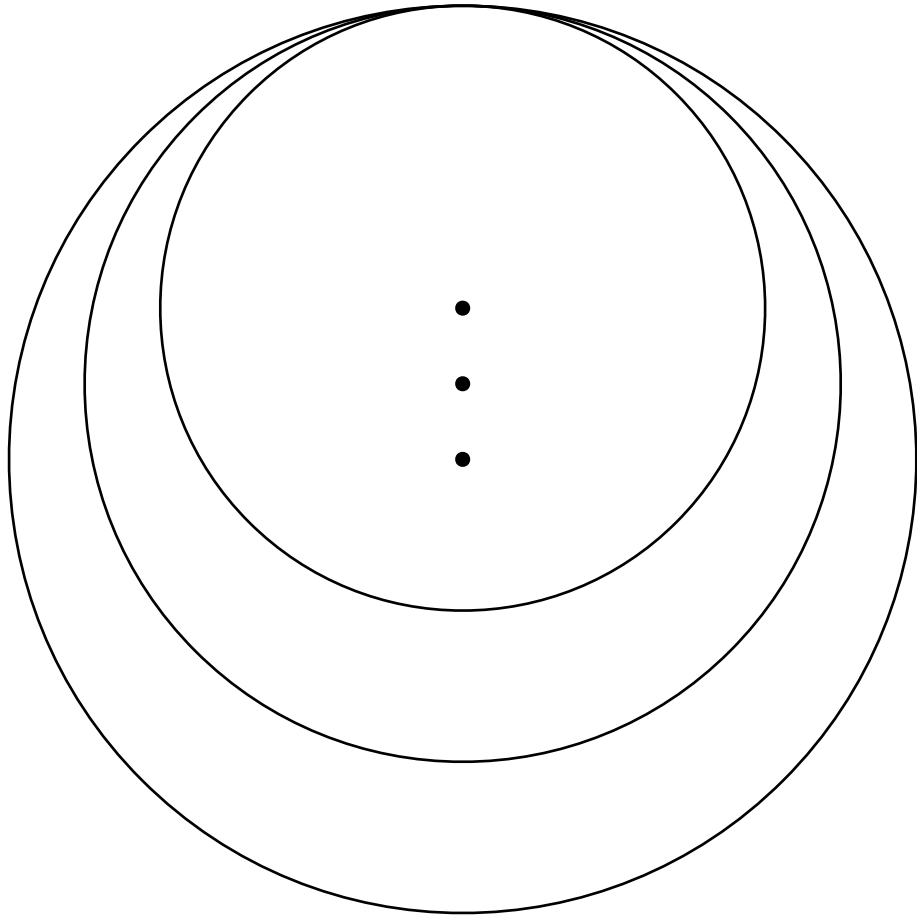

CIRCULUS

7

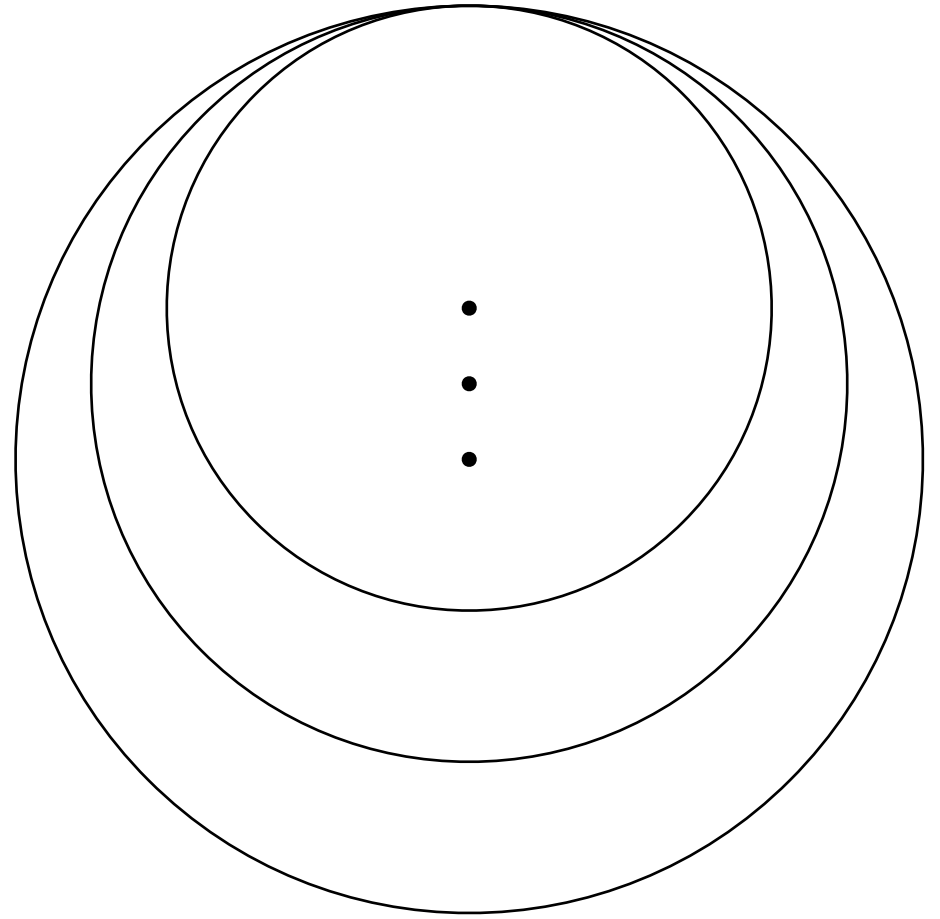

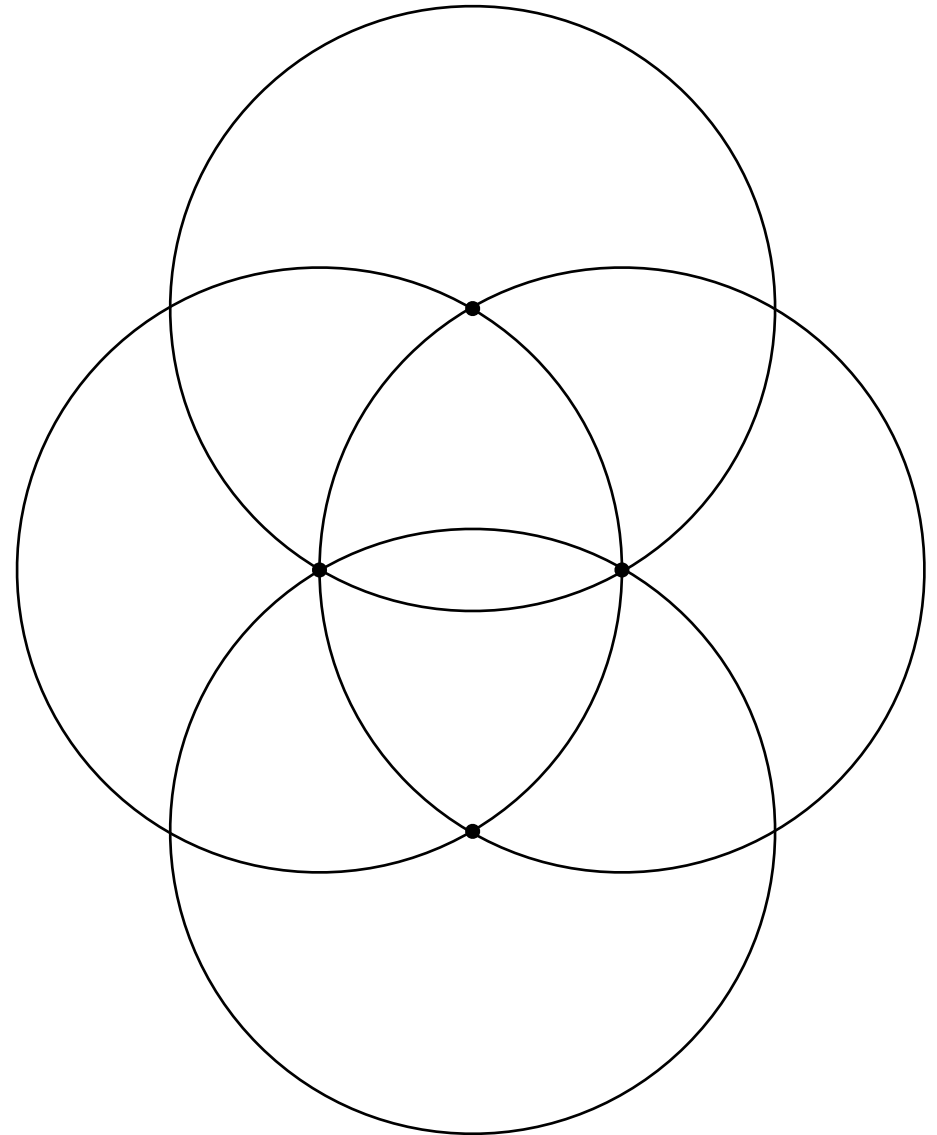
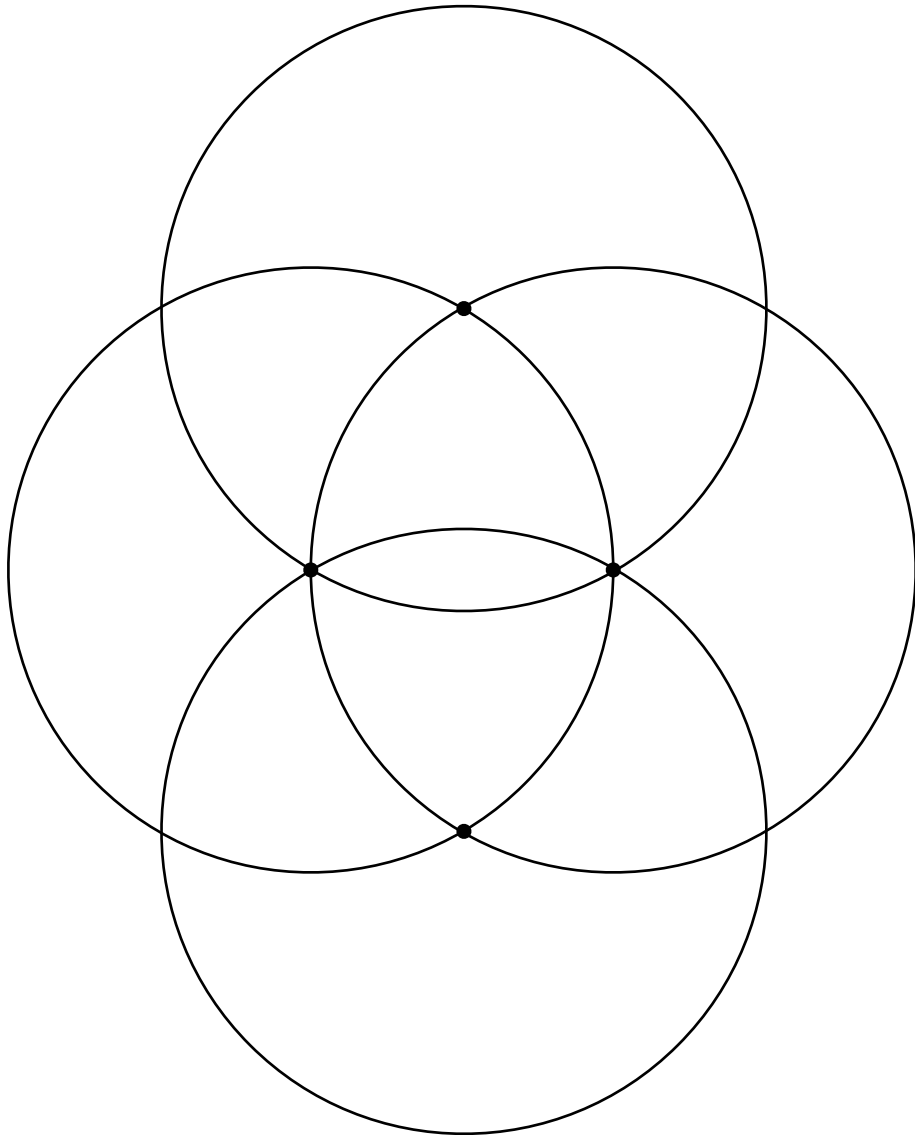

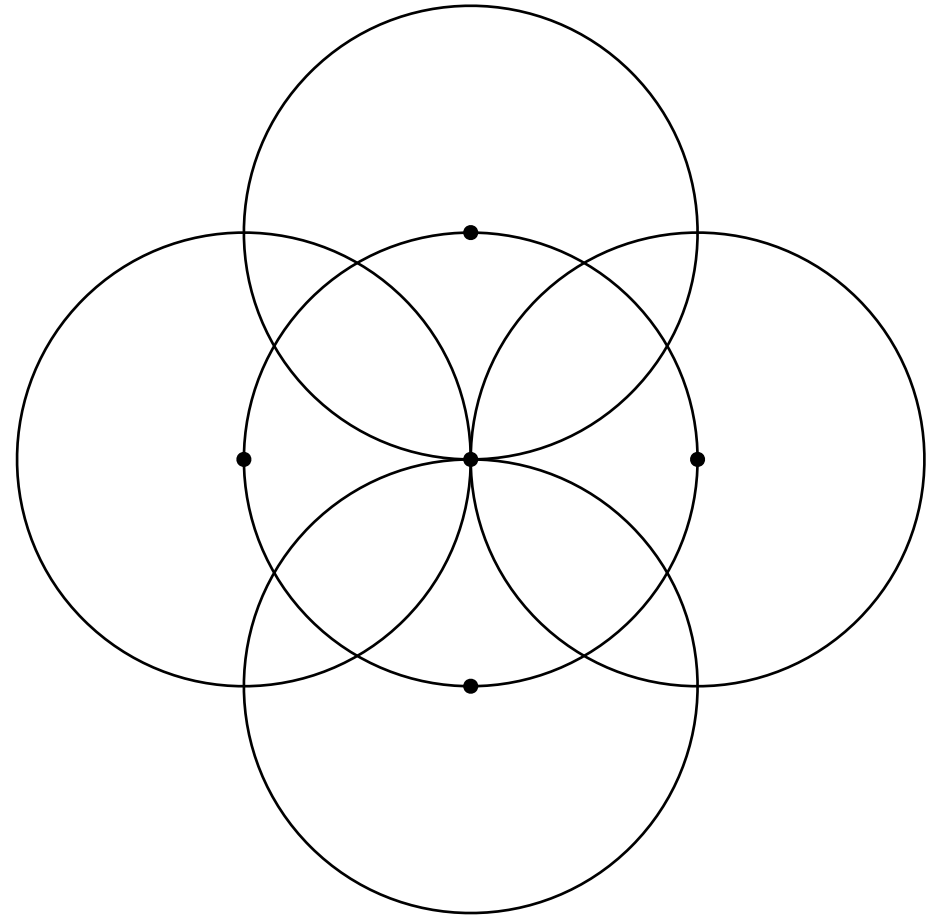
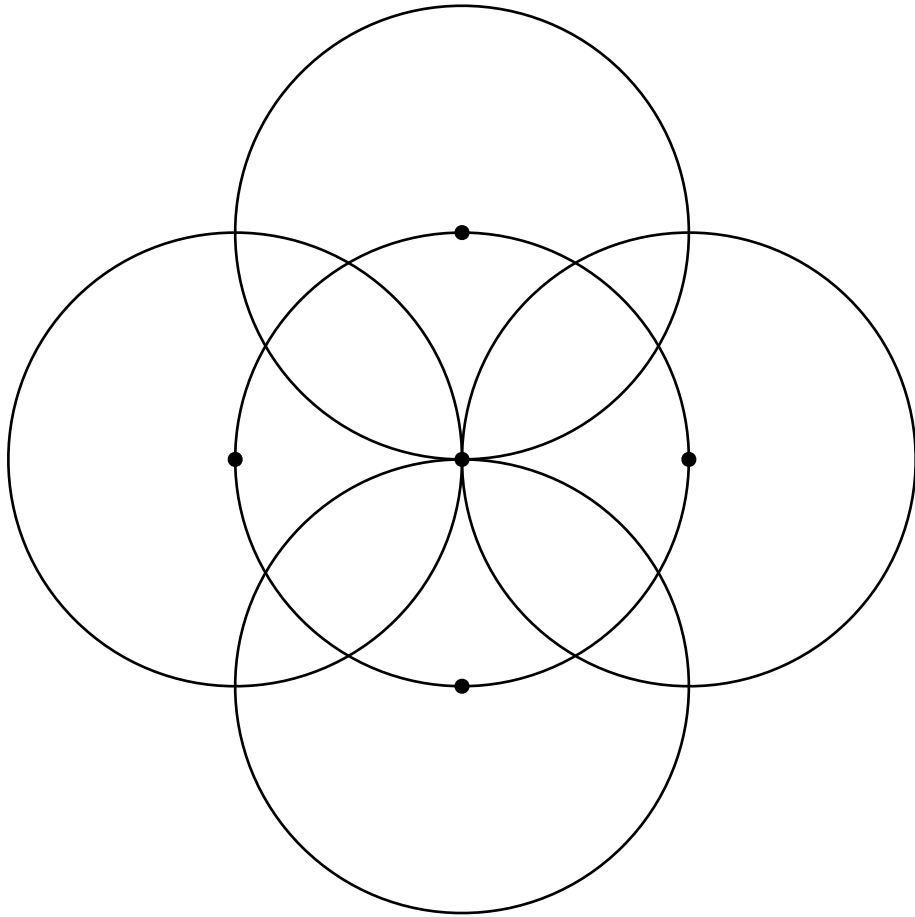

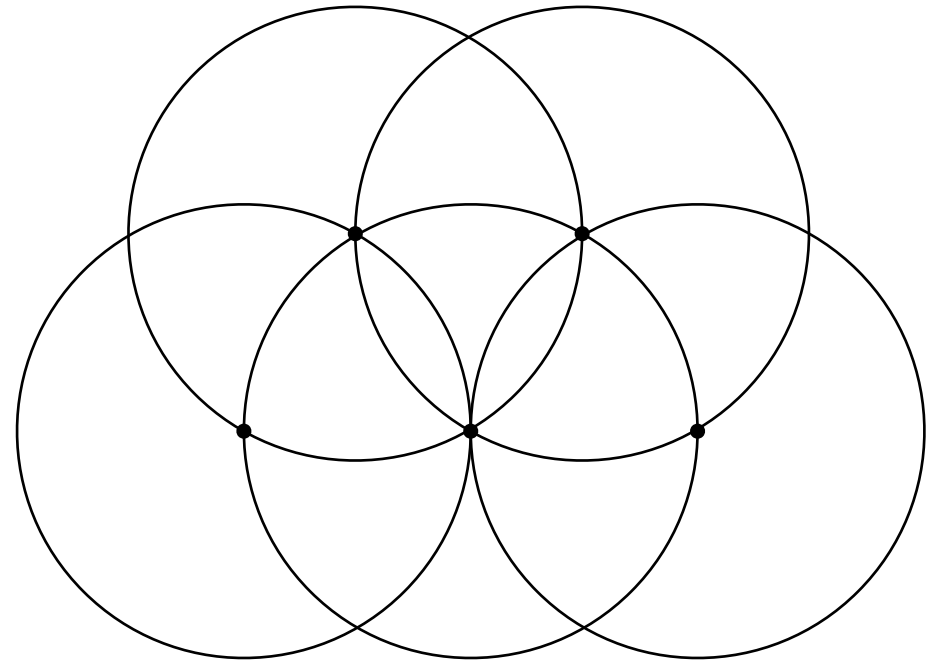
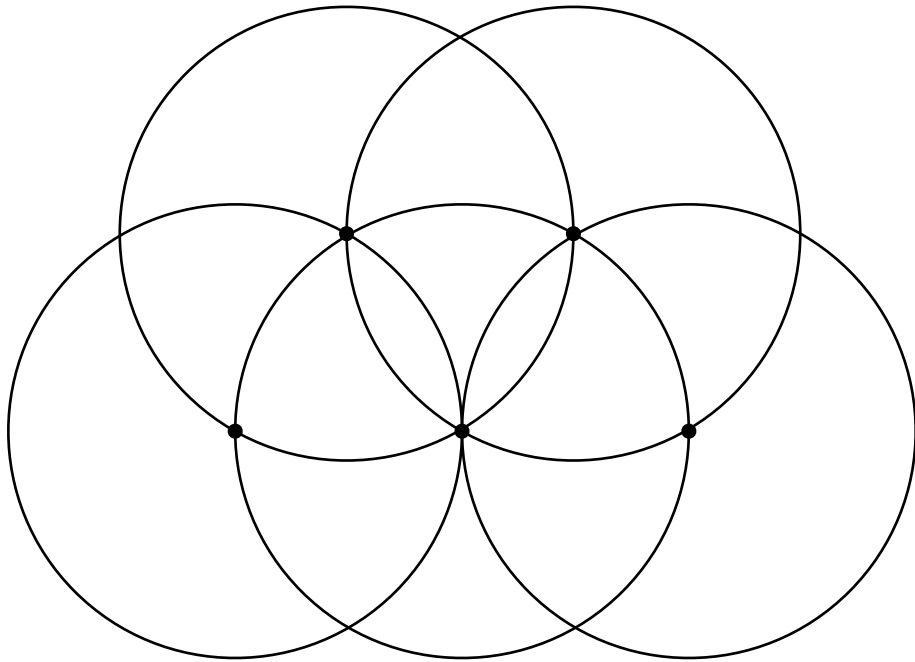

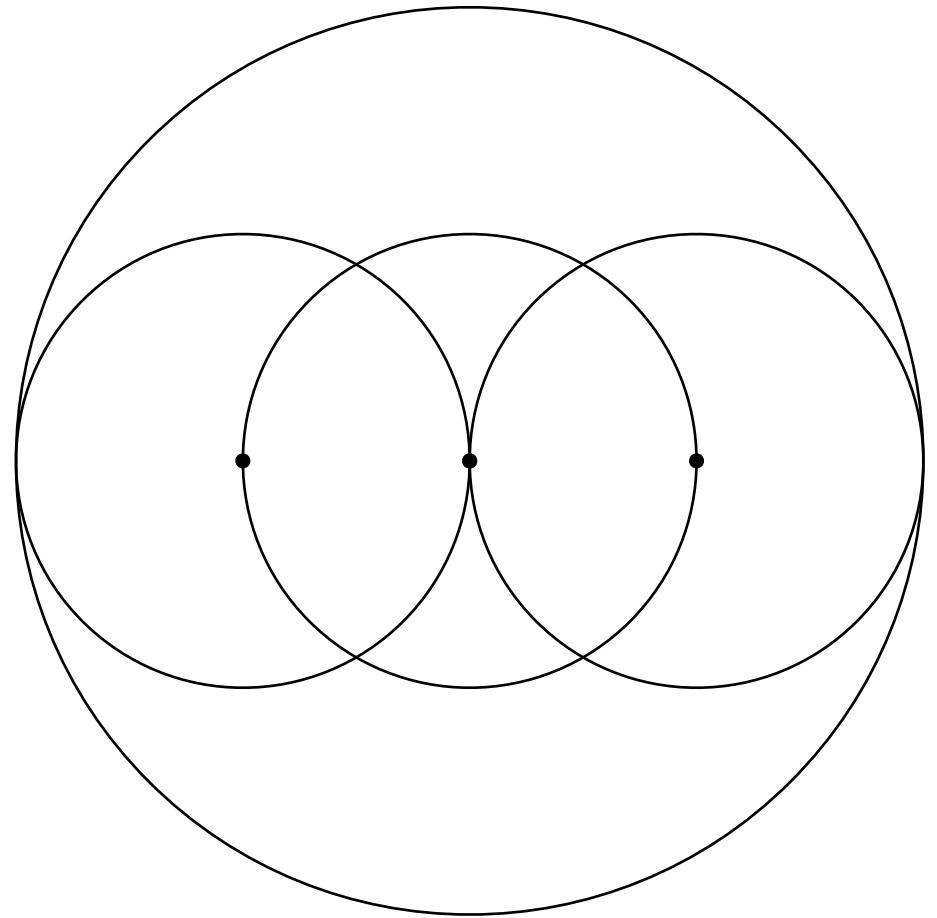
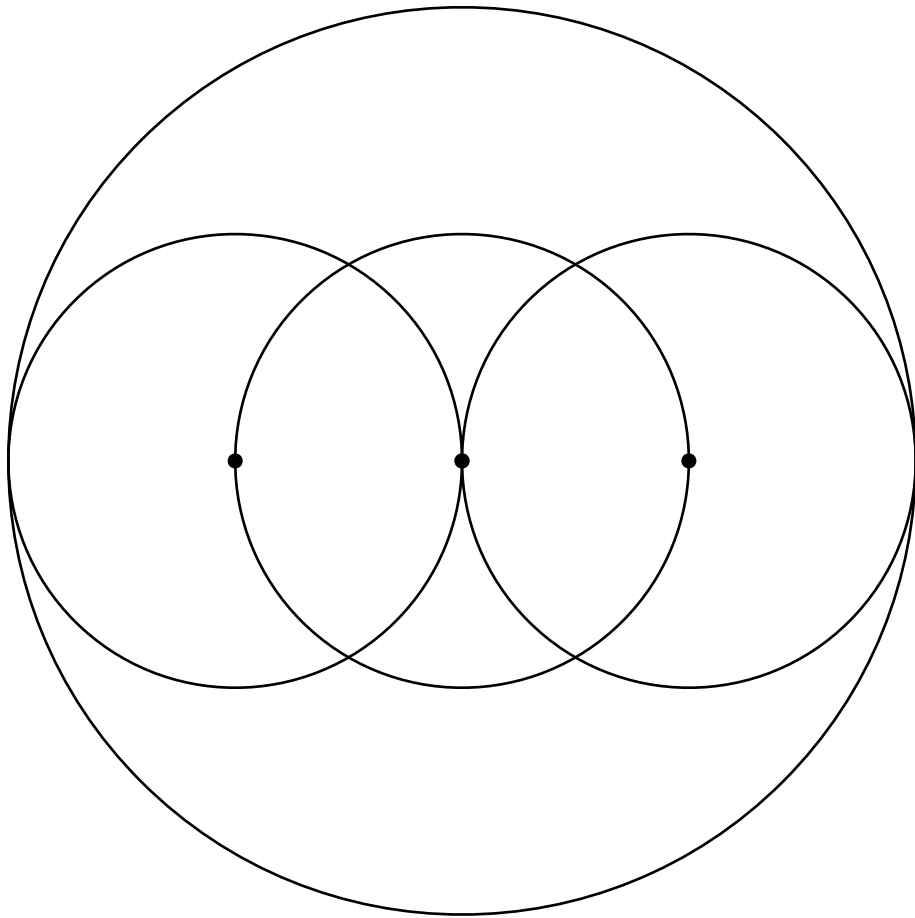

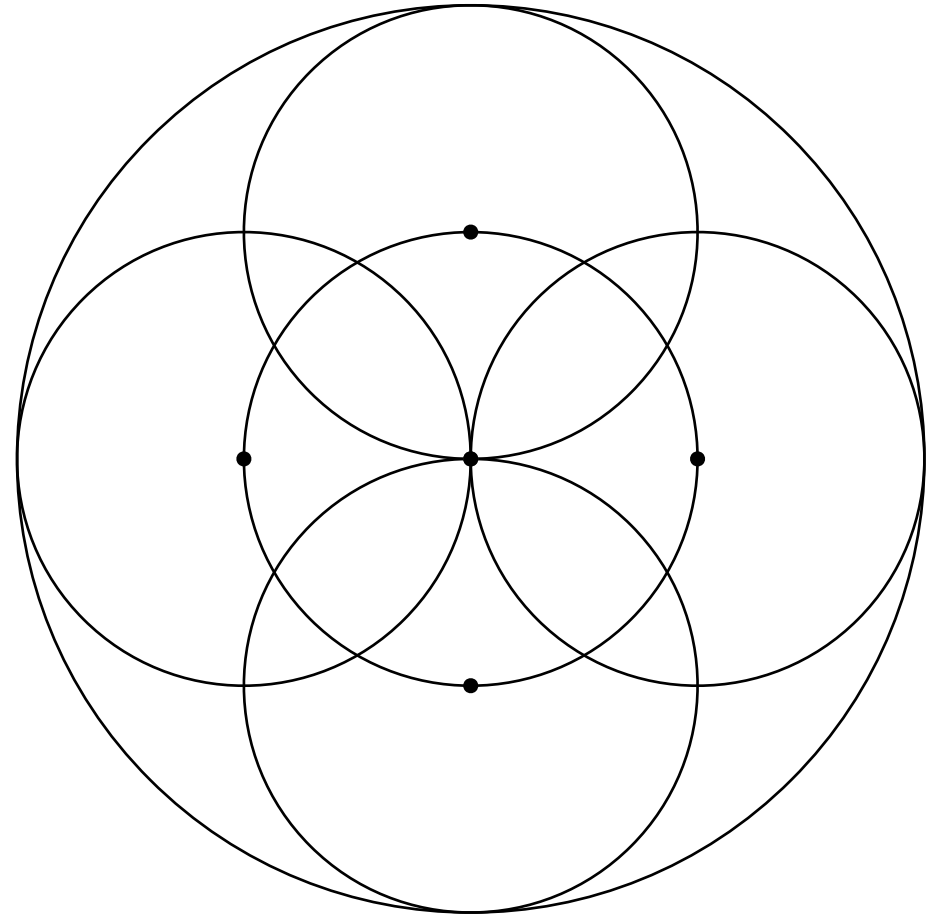
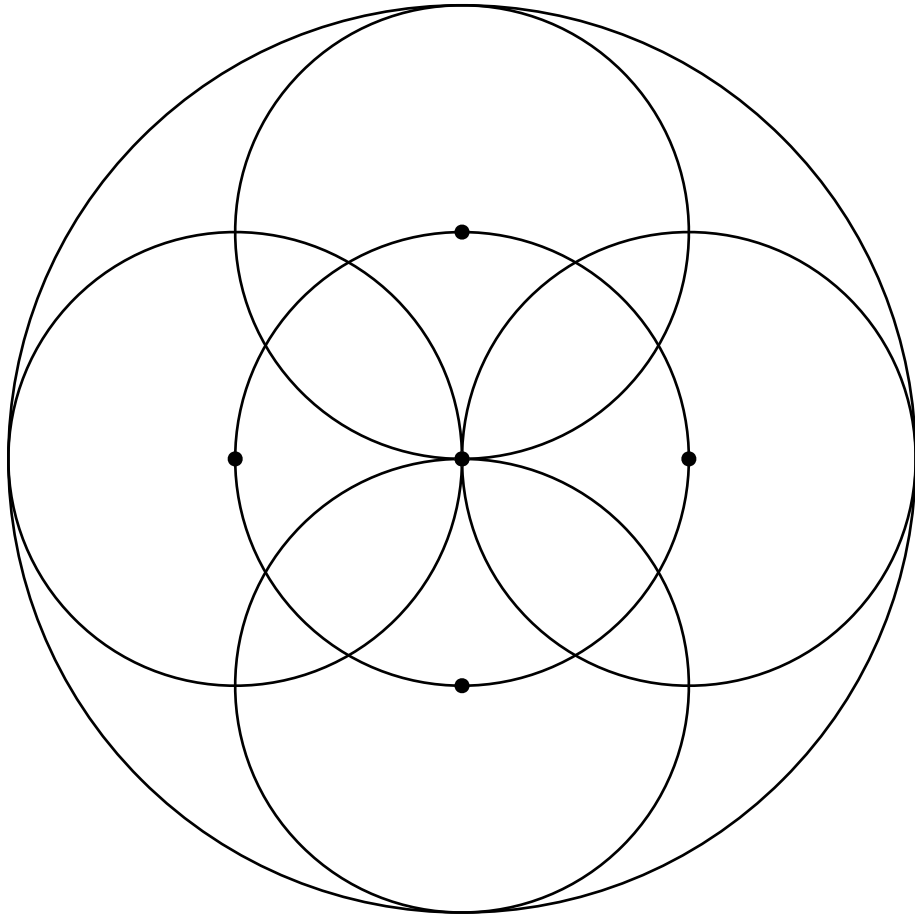

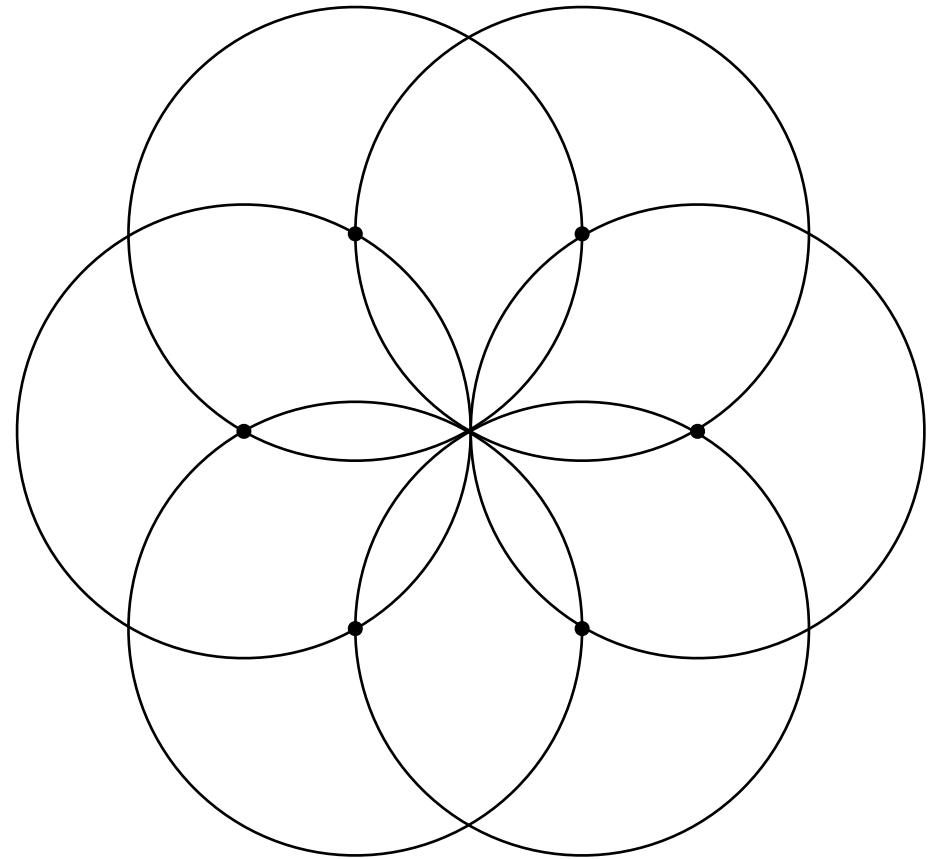
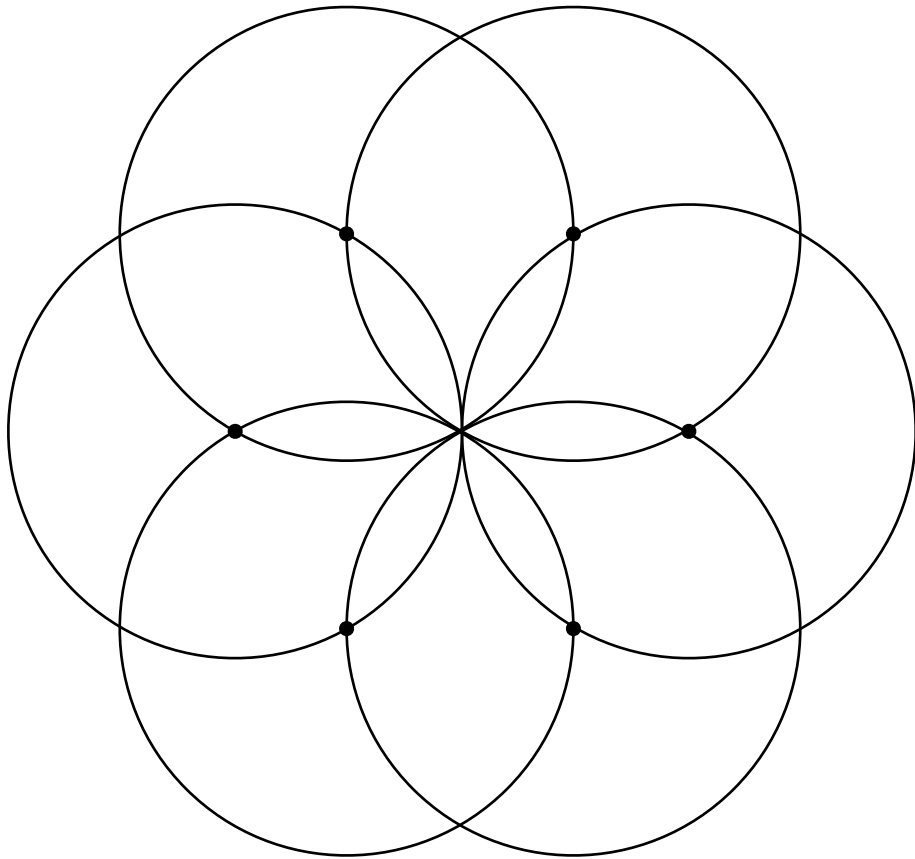

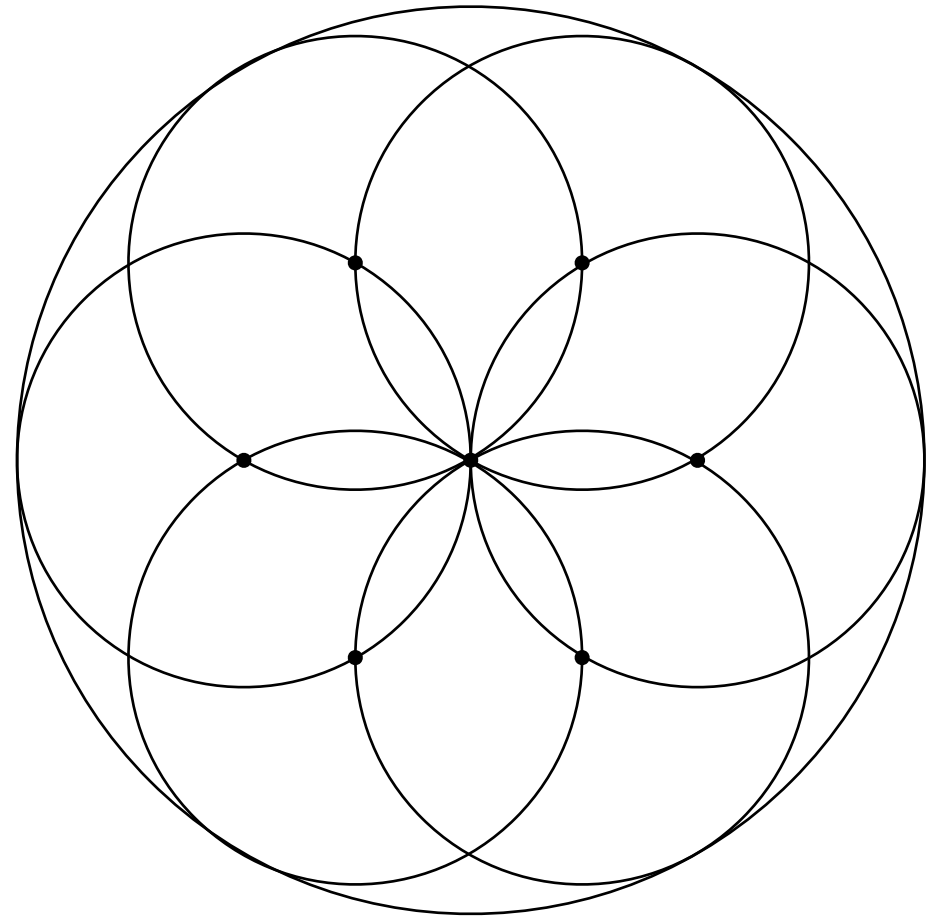
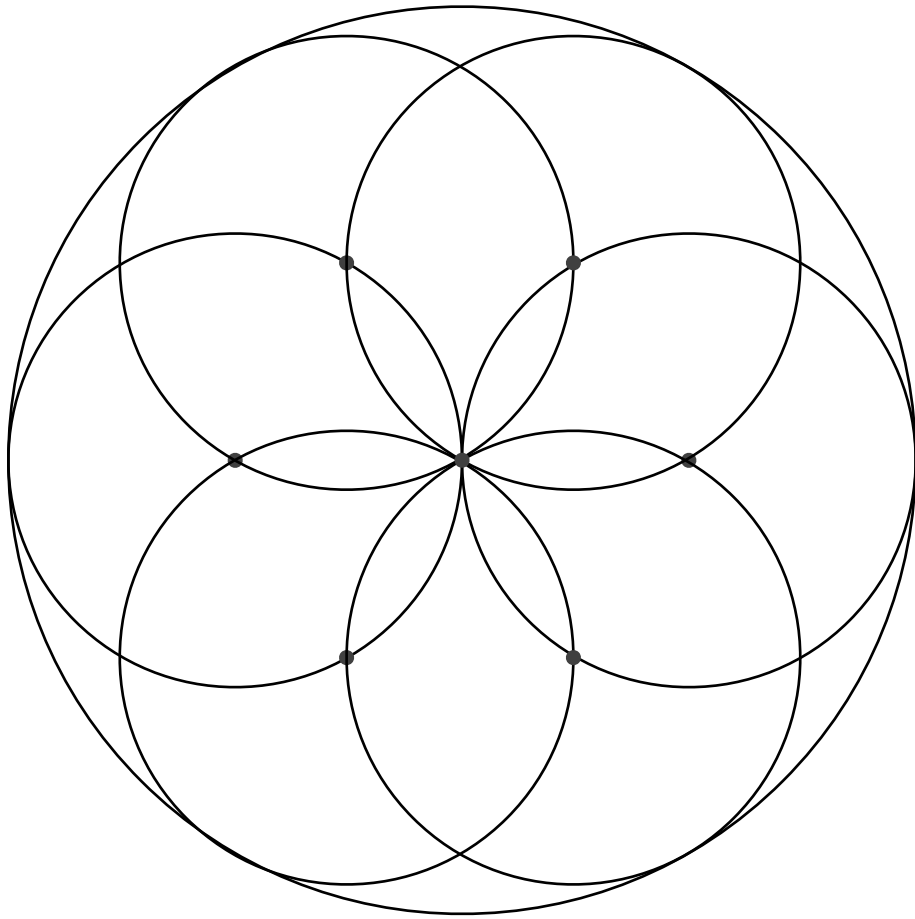

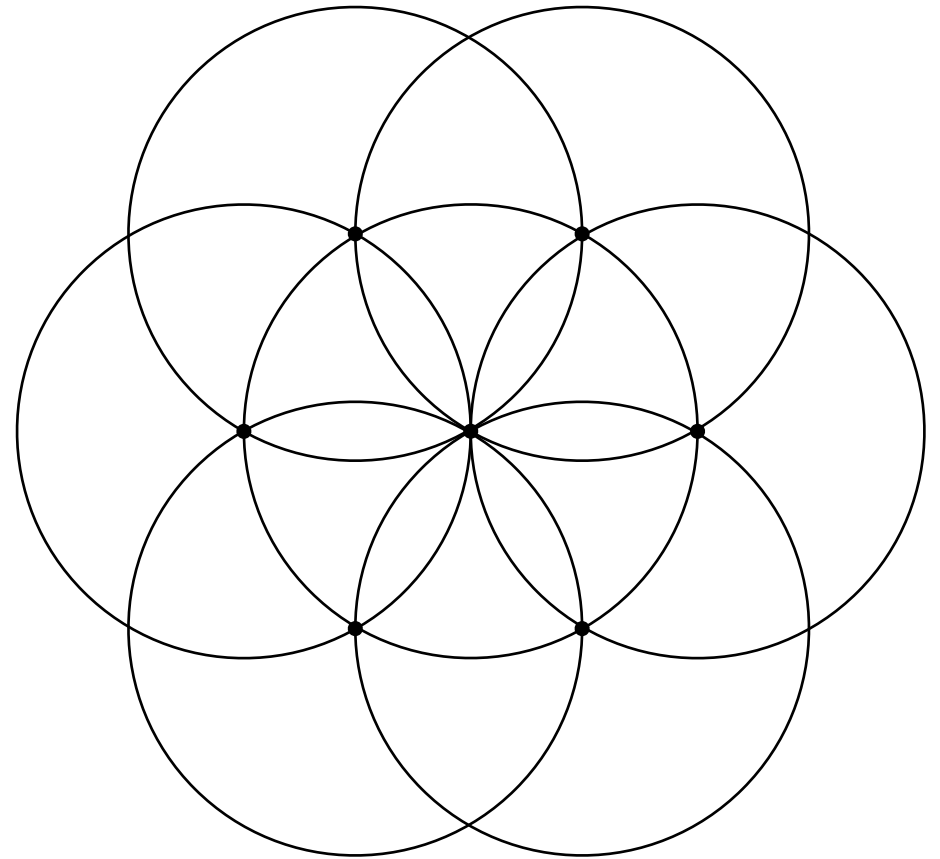
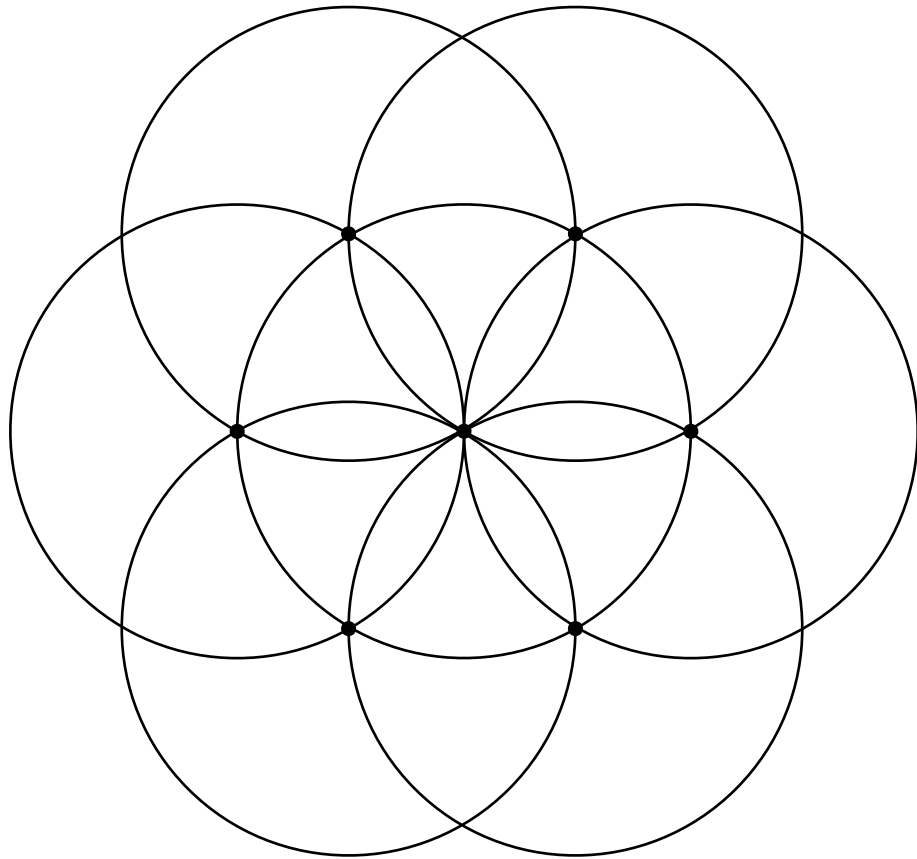

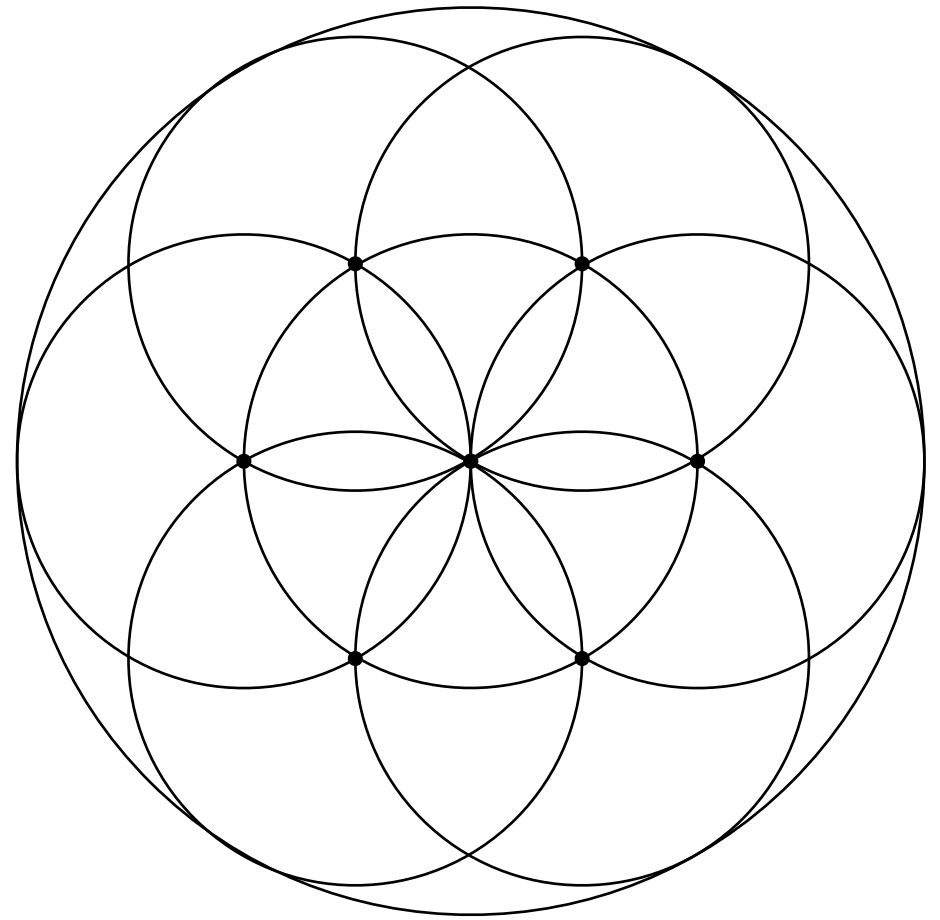
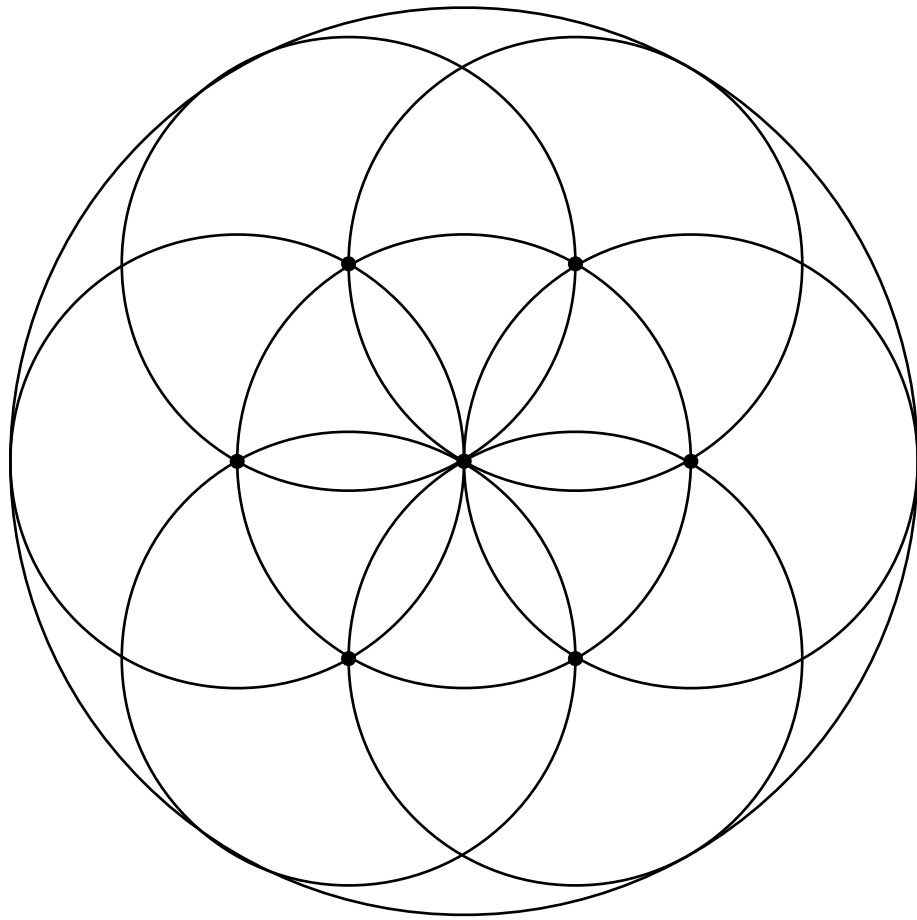

CIRCULUS

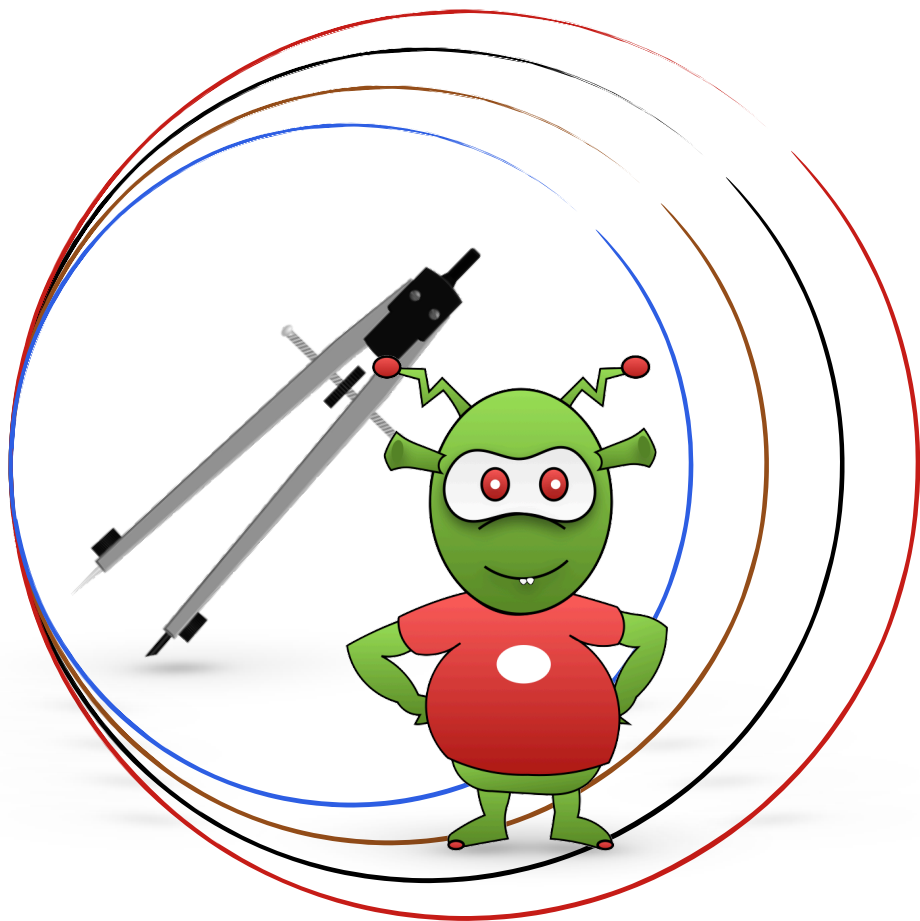

17 18 19 20 21 22 23 24 25 26 27 28 29 30 31 32

NIVEAU 5 NIVEAU 6 NIVEAU 7 NIVEAU 8

CIRCULUS

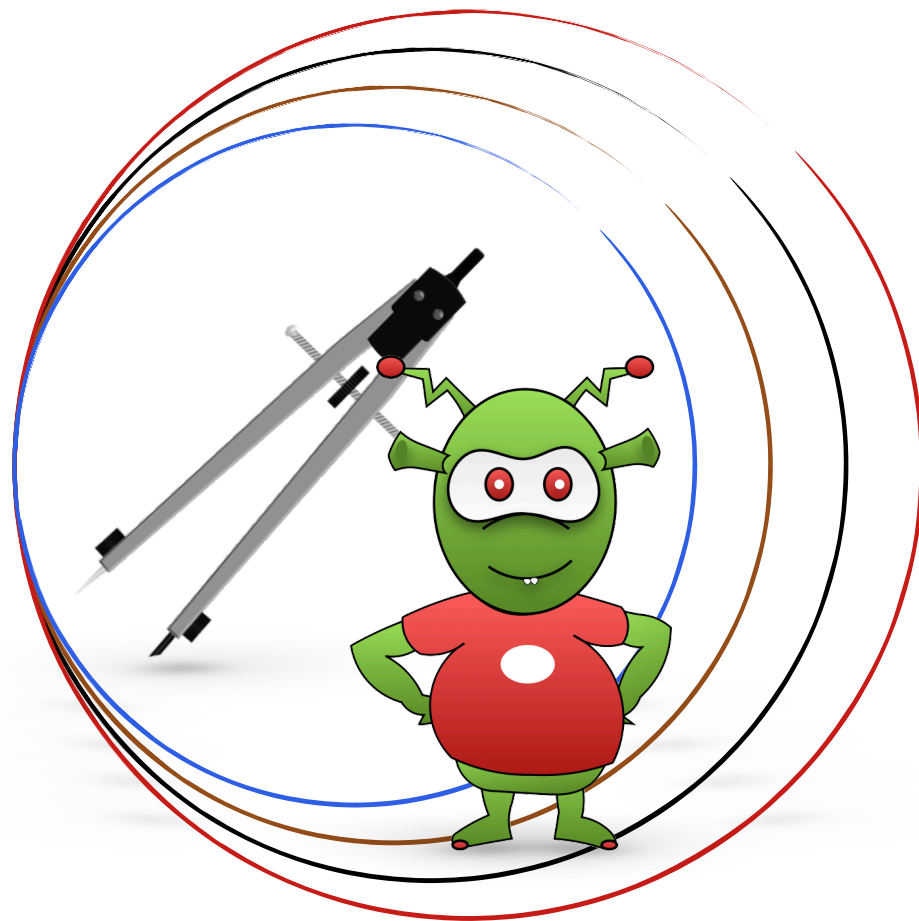

17 18 19 20 21 22 23 24 25 26 27 28 29 30 31 32

NIVEAU 5 NIVEAU 6 NIVEAU 7 NIVEAU 8

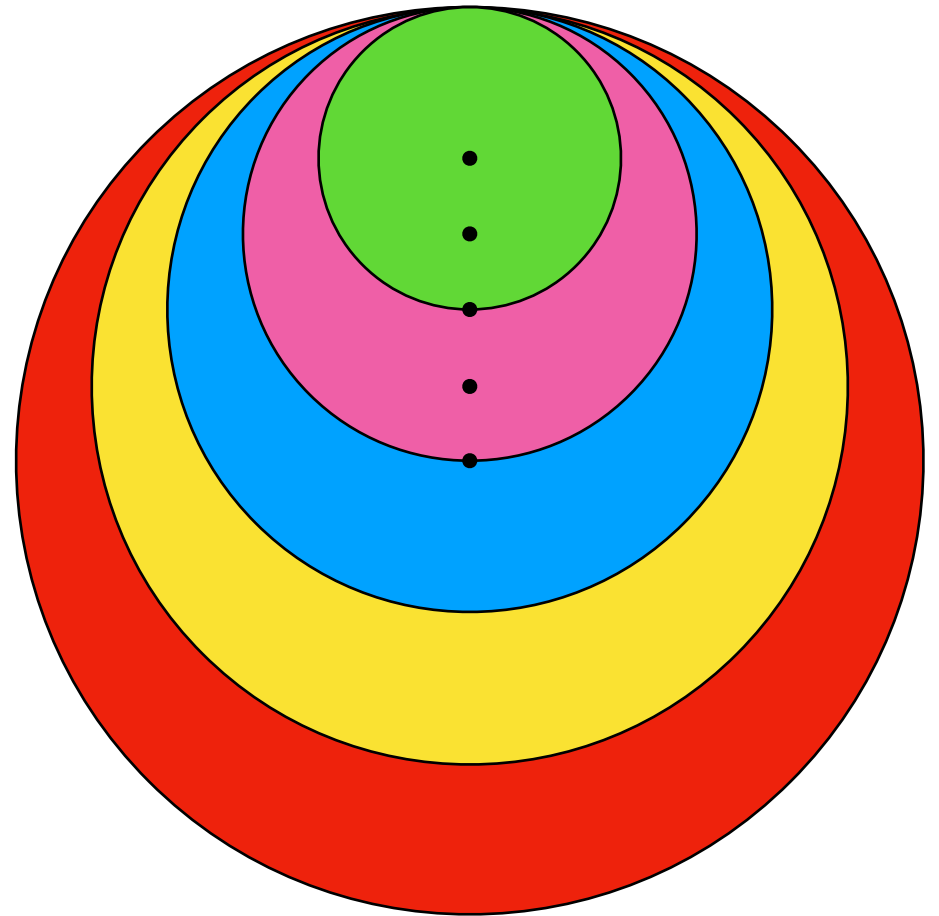
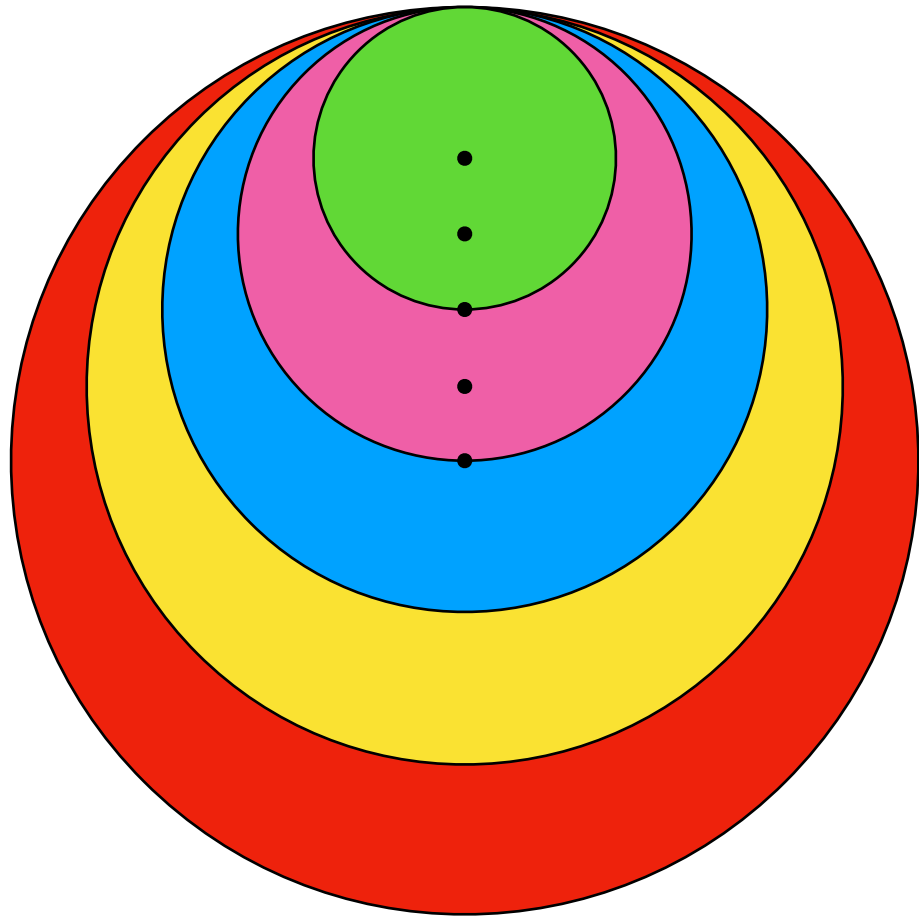

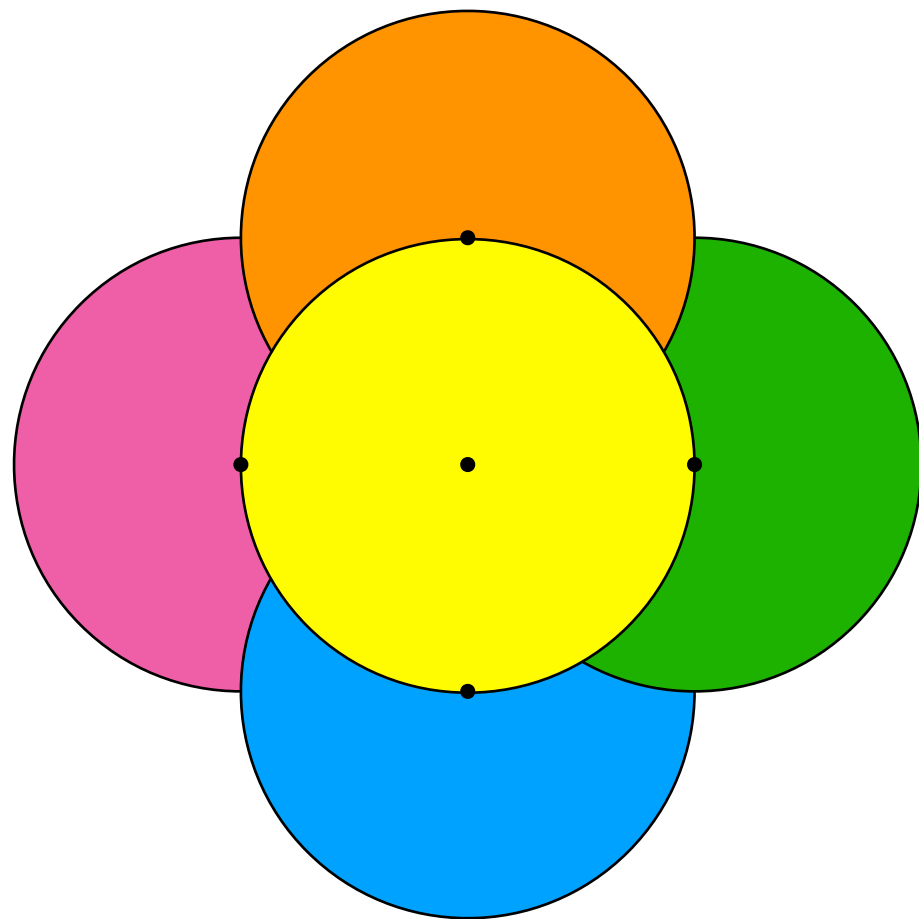
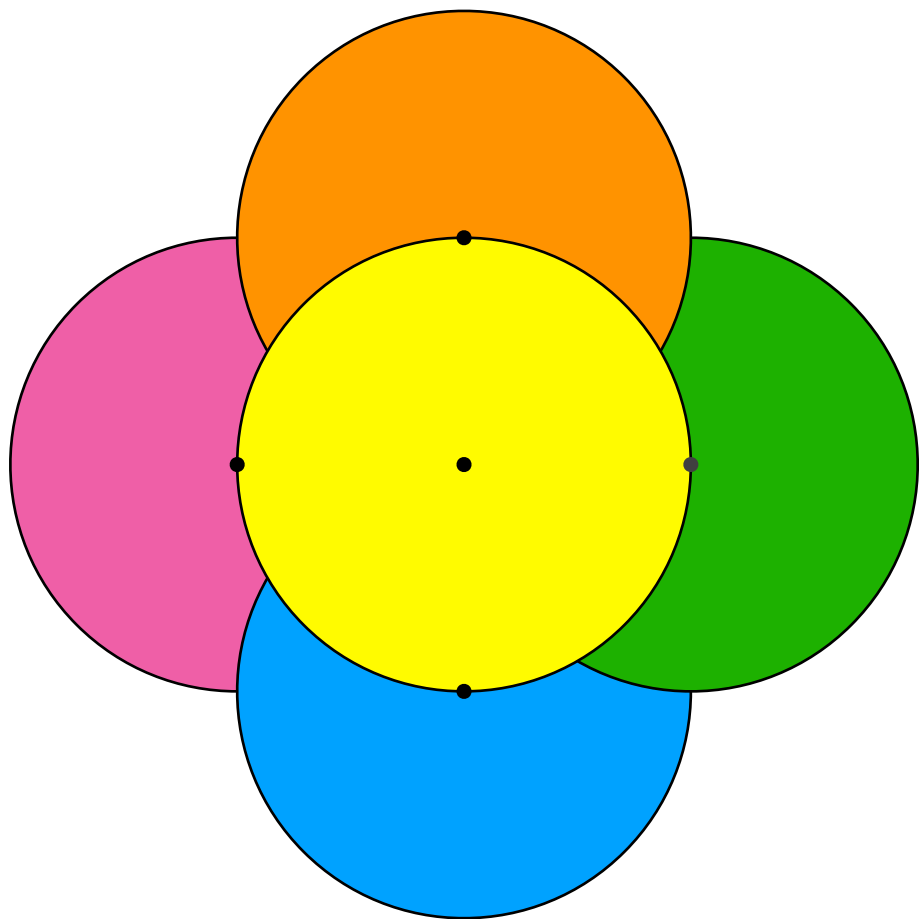

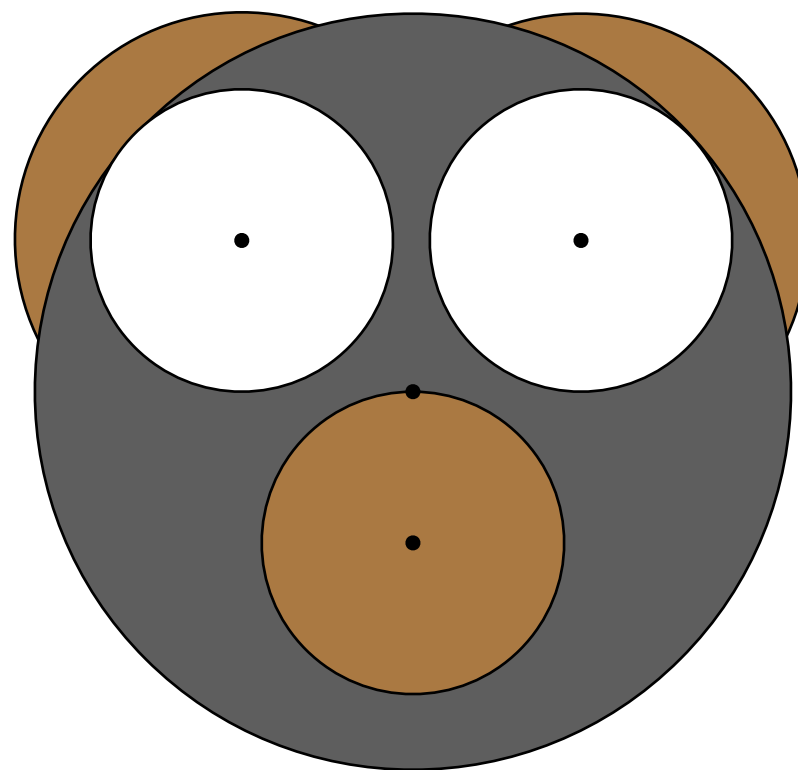

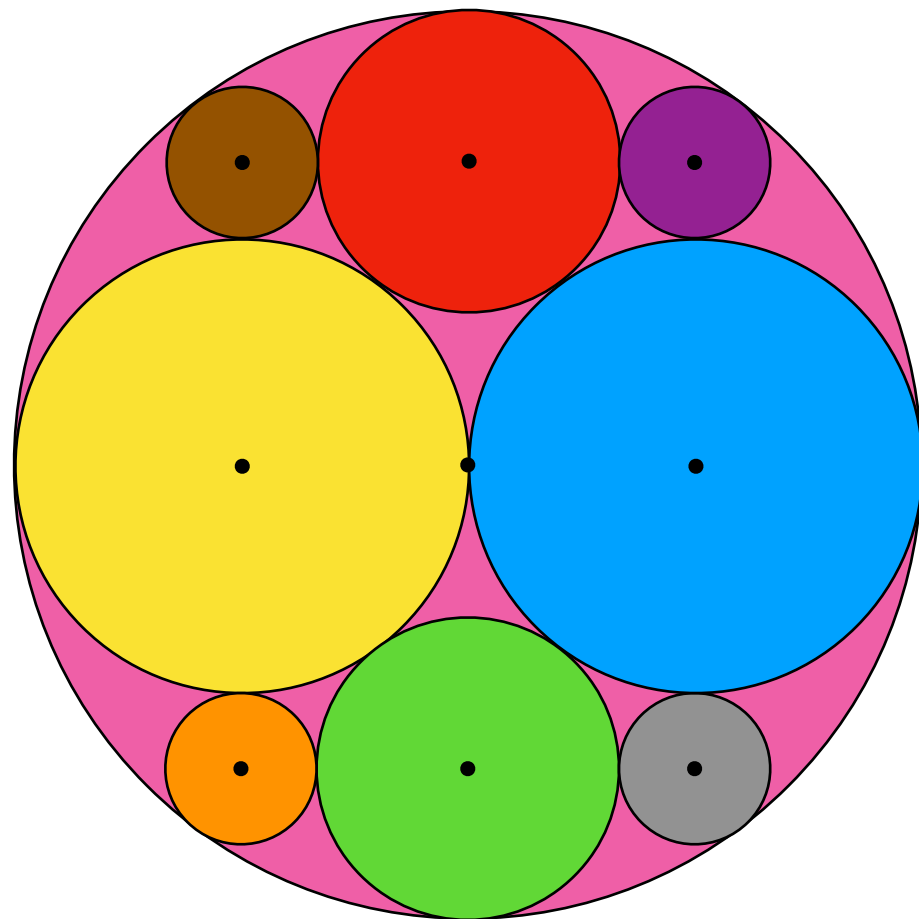
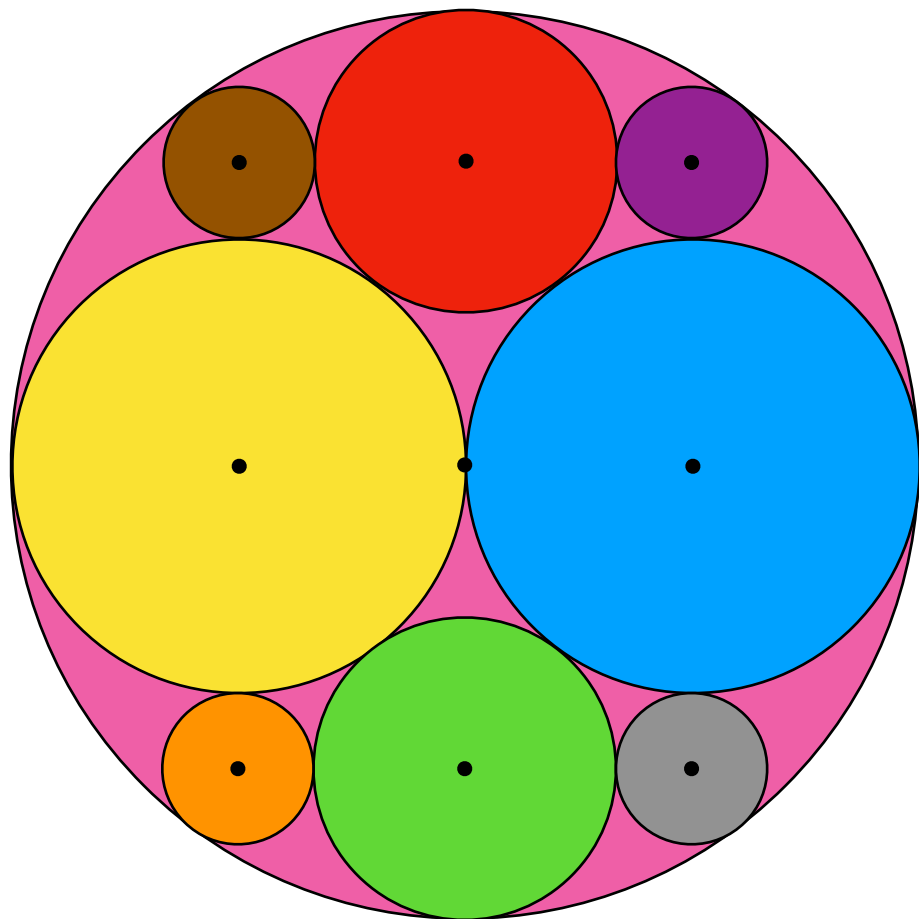

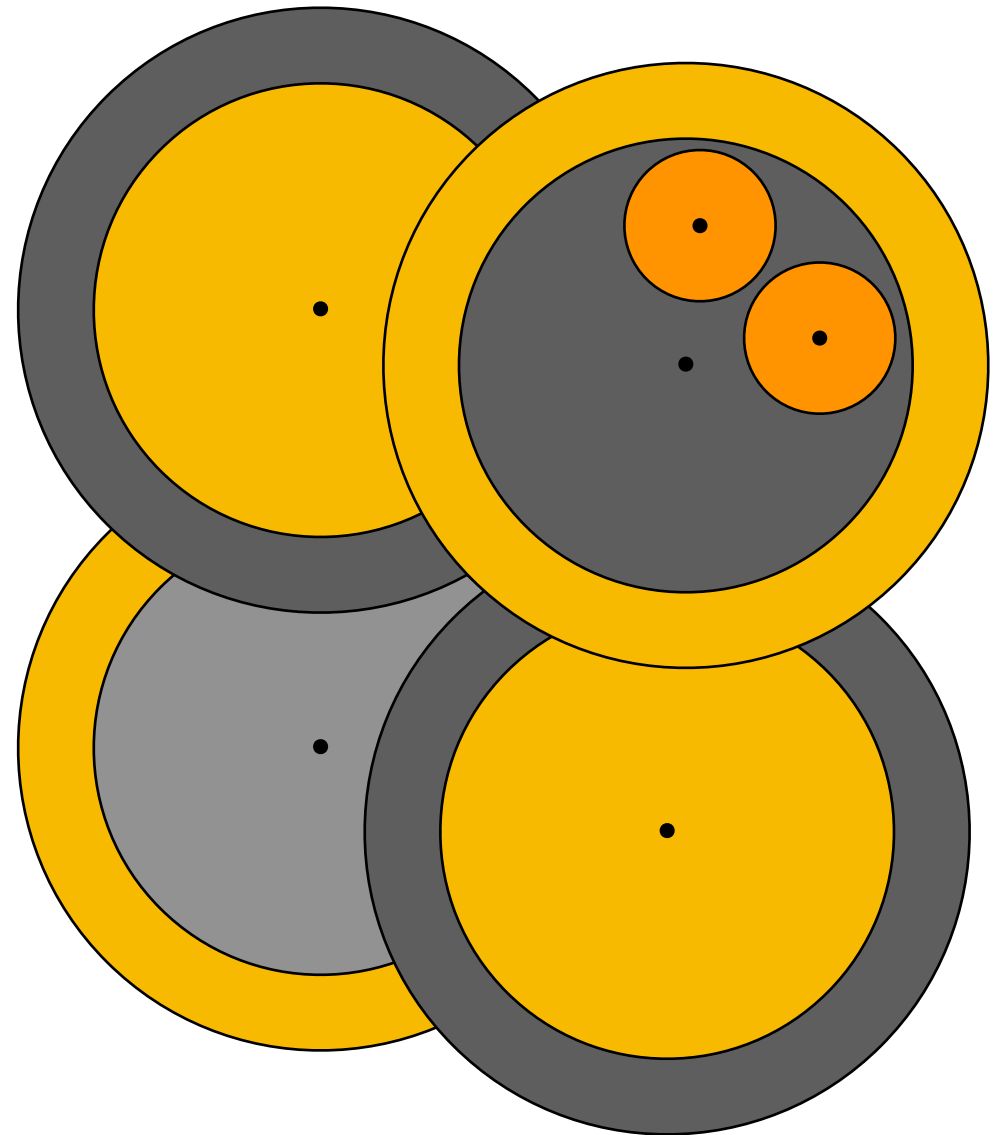
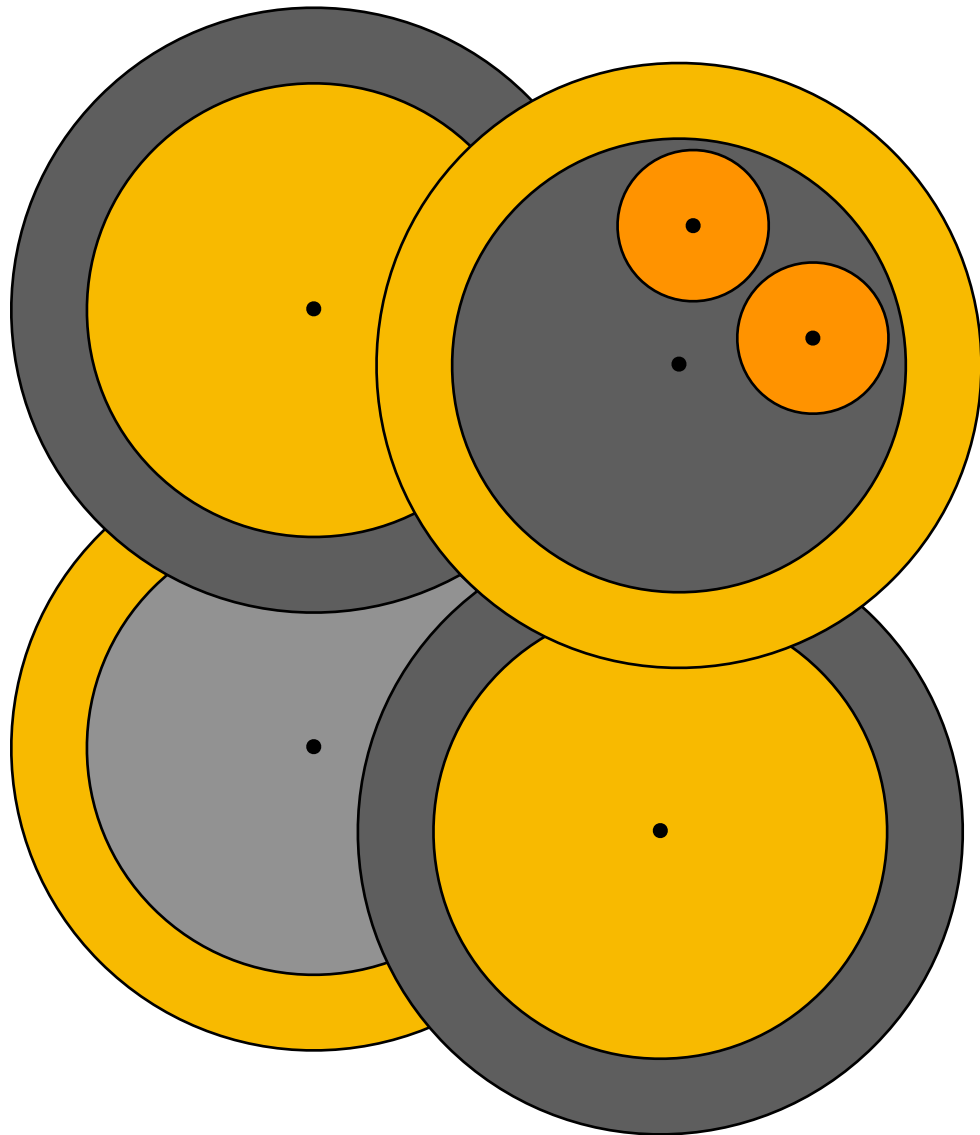

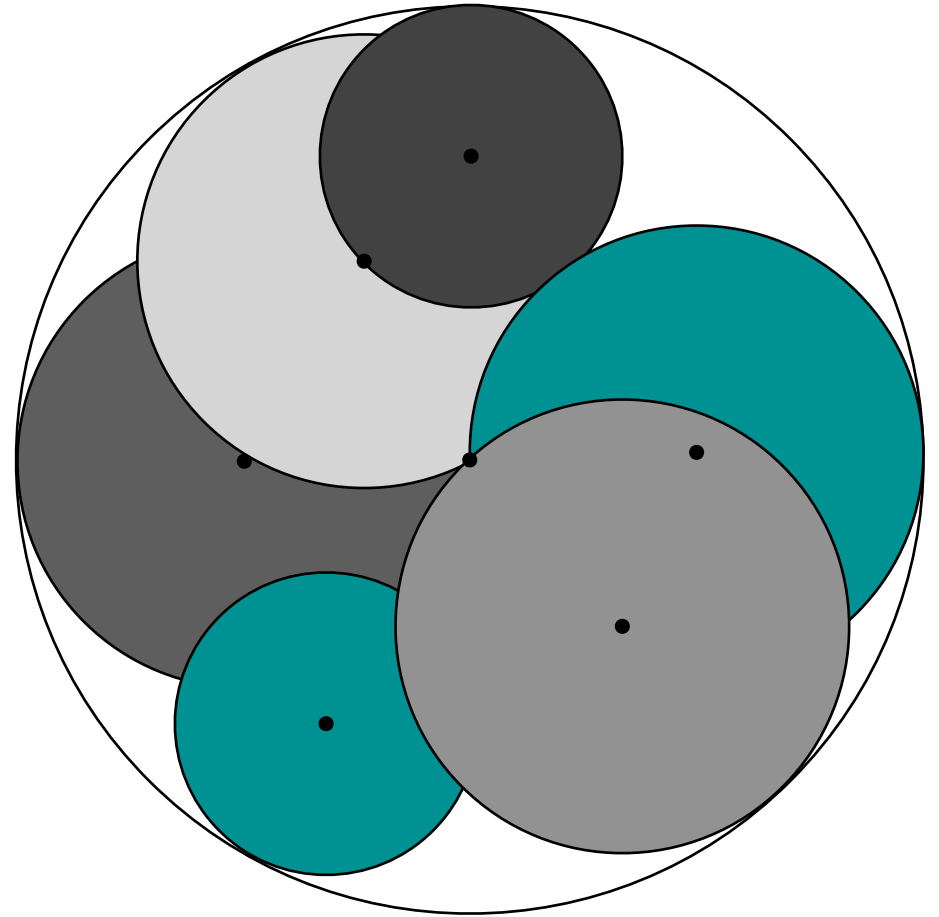
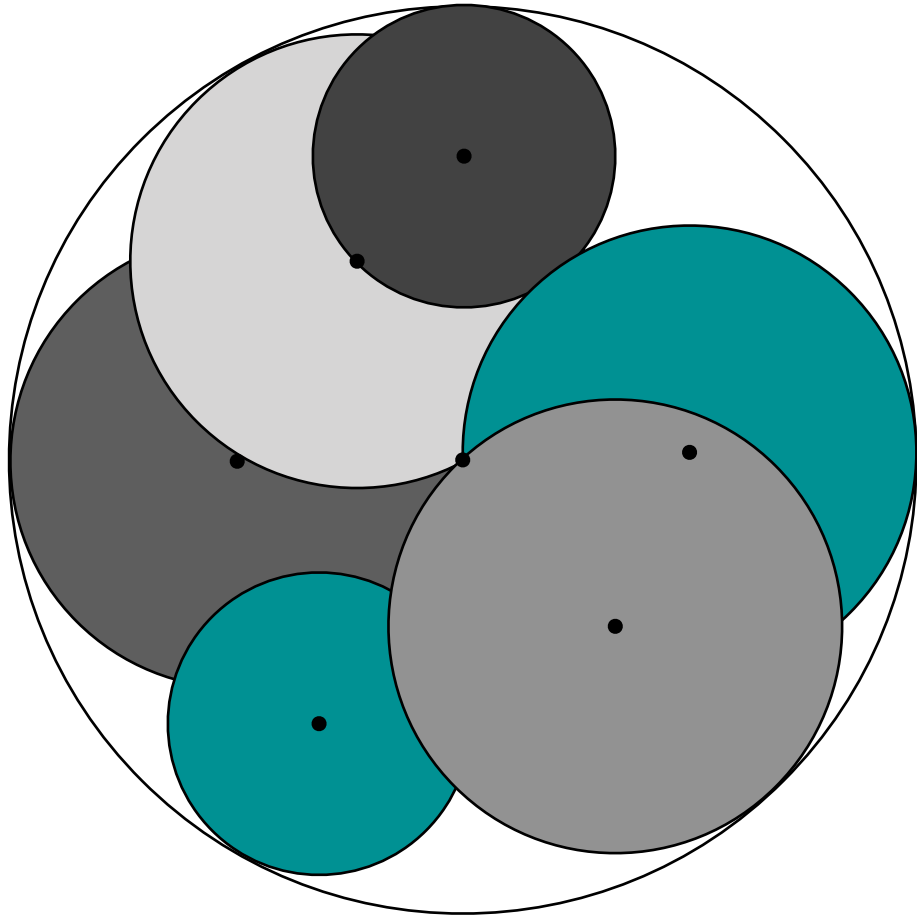

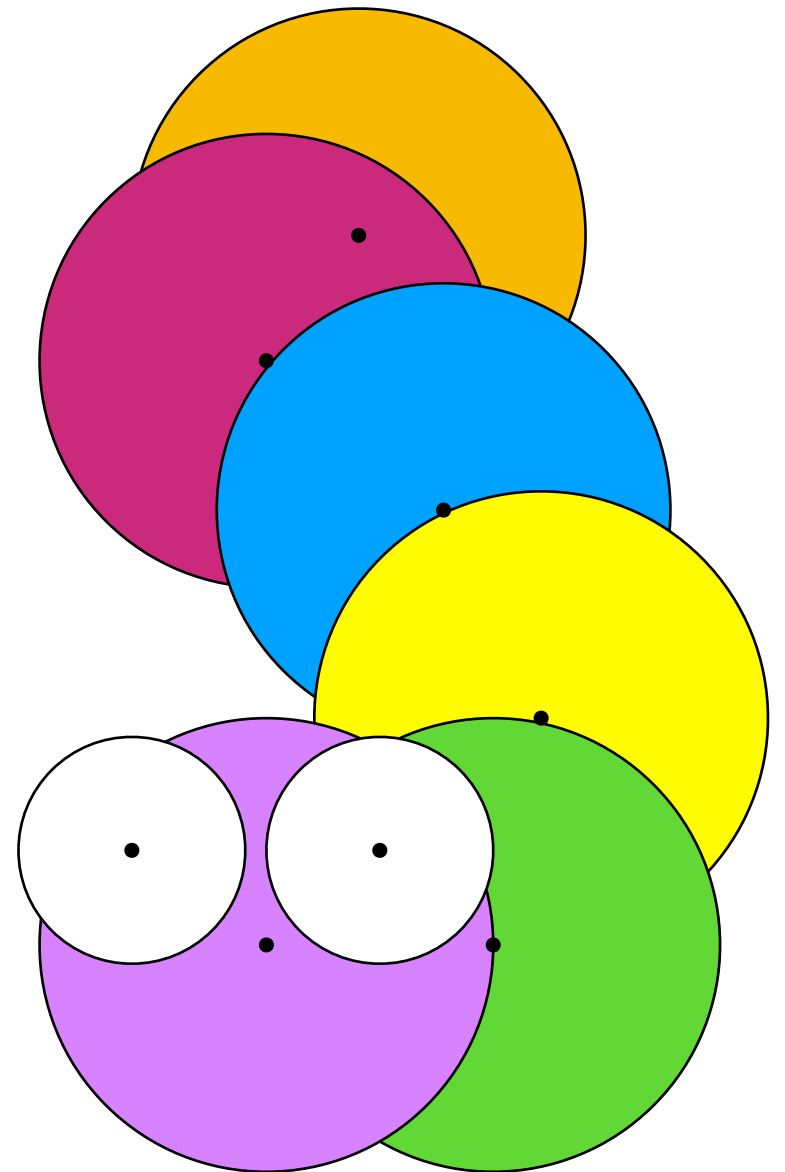
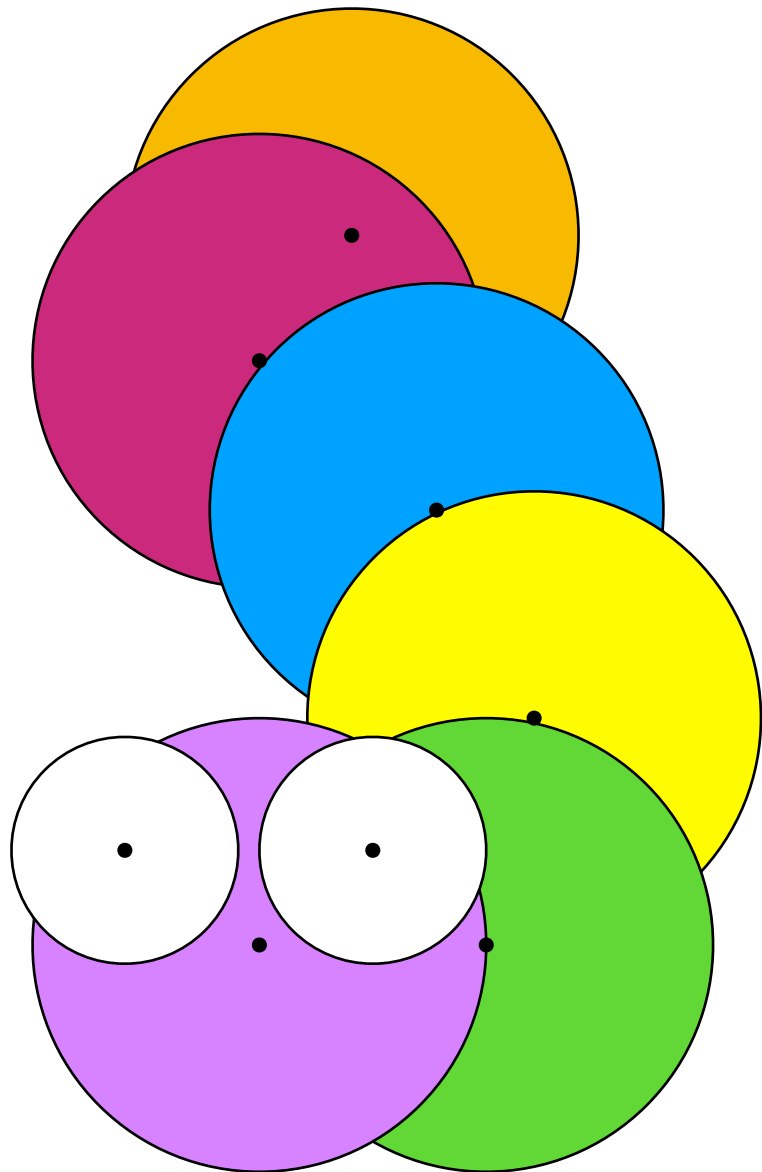

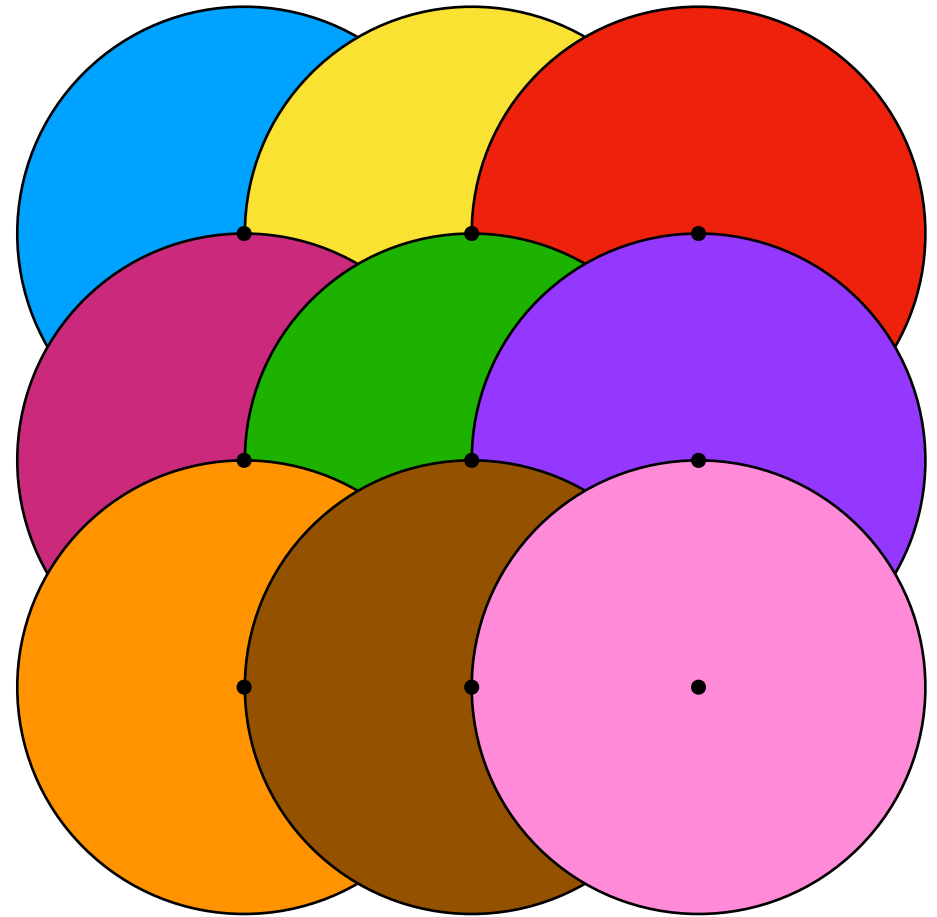
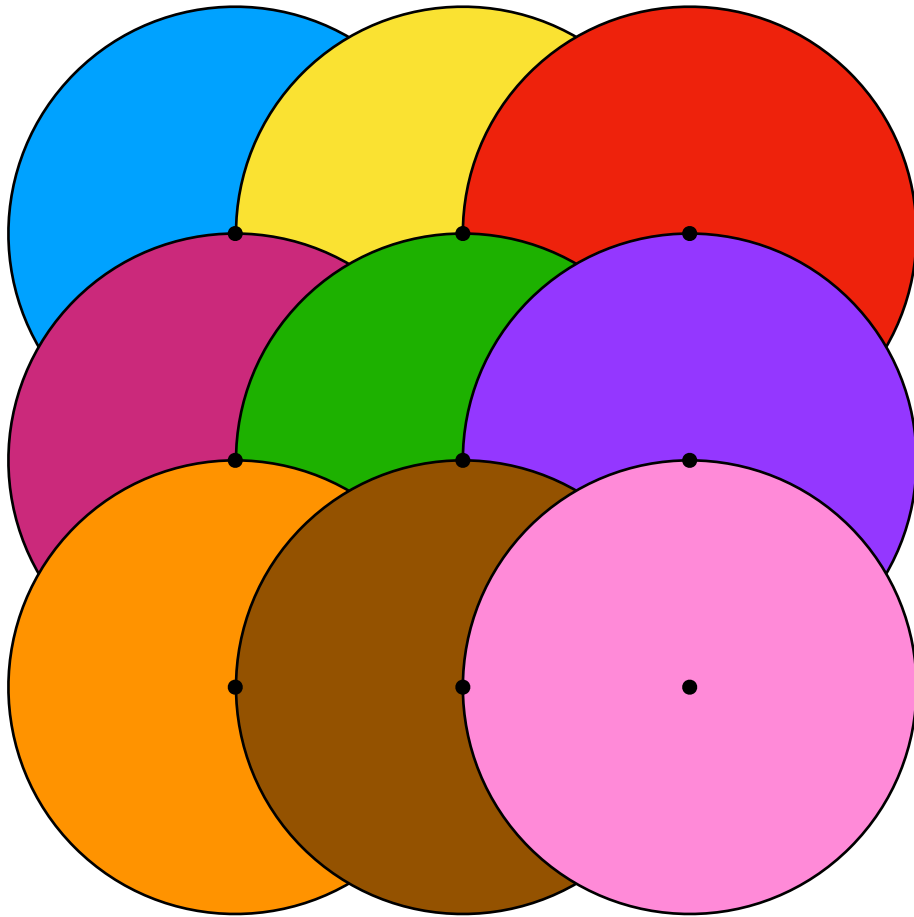

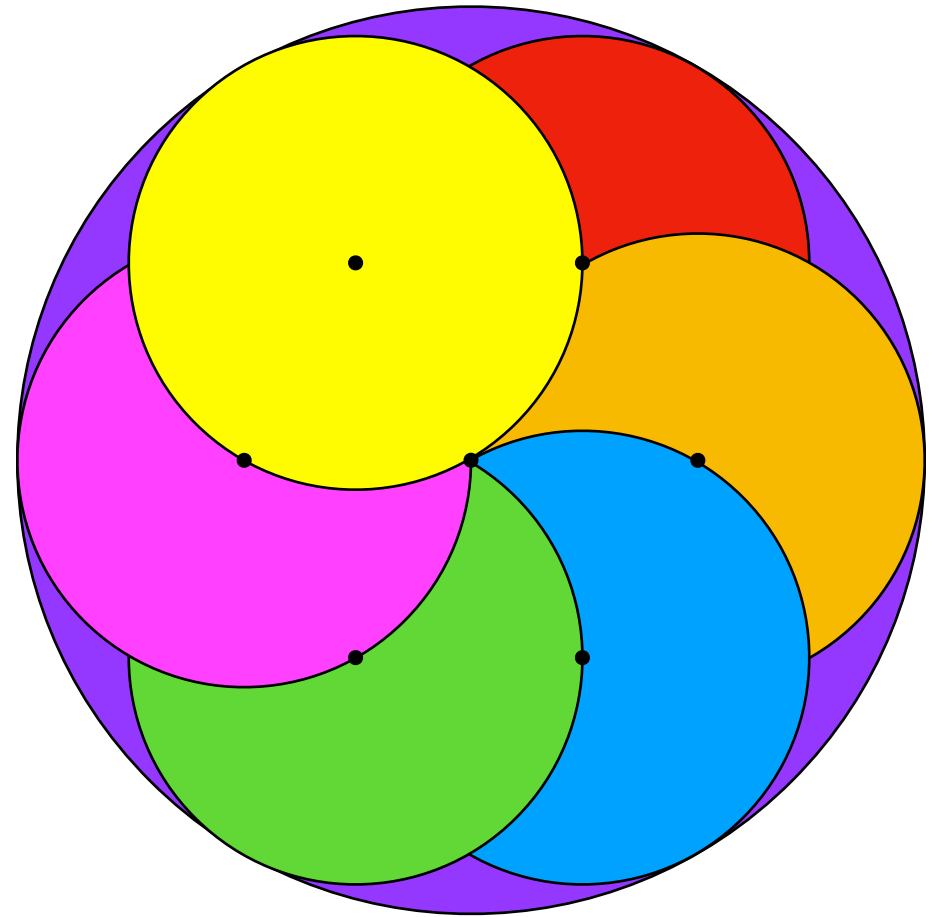
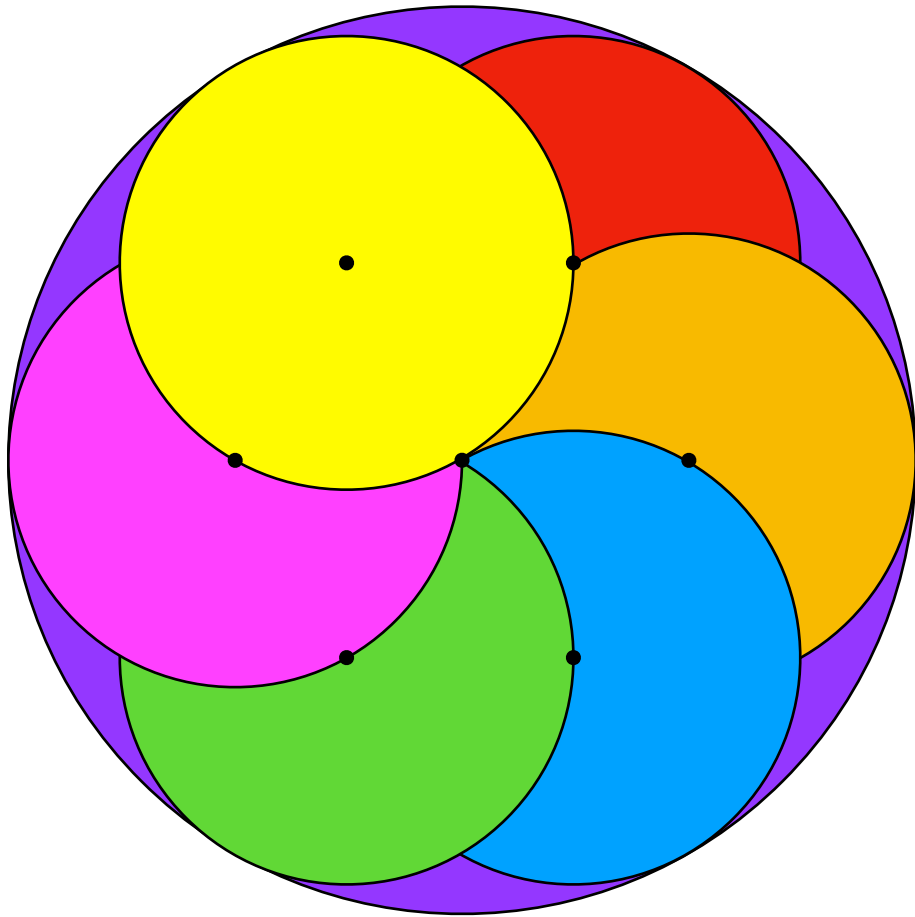

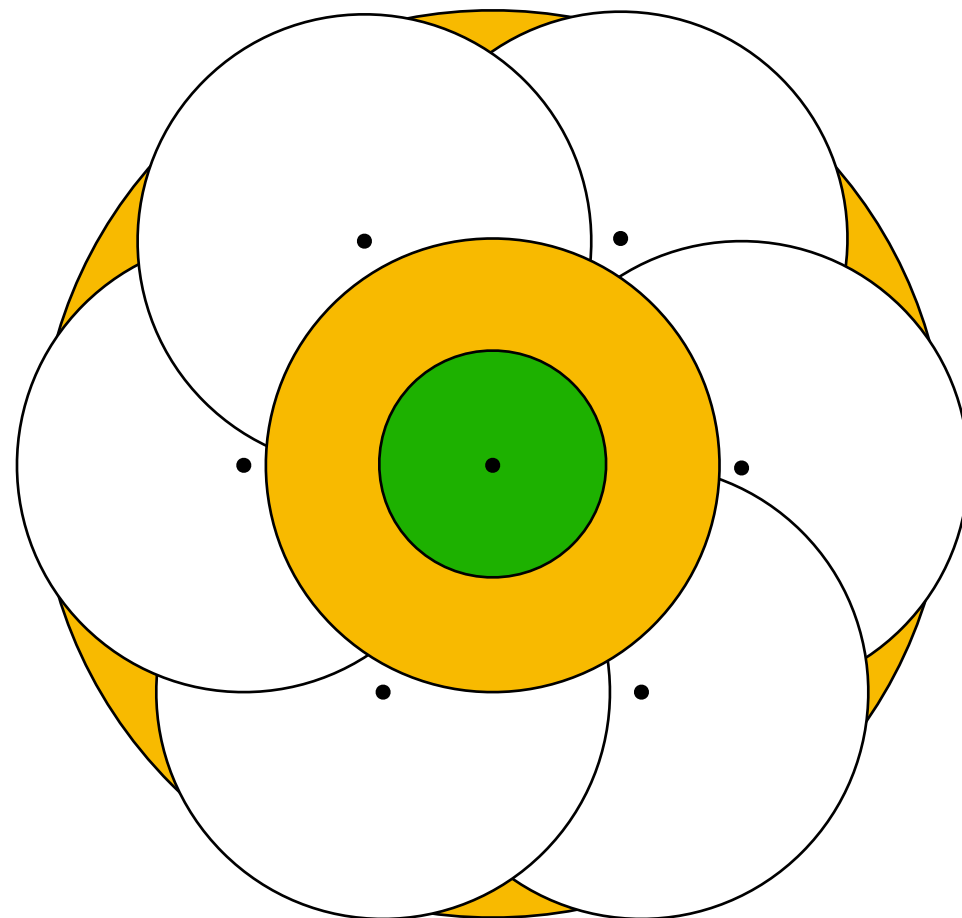
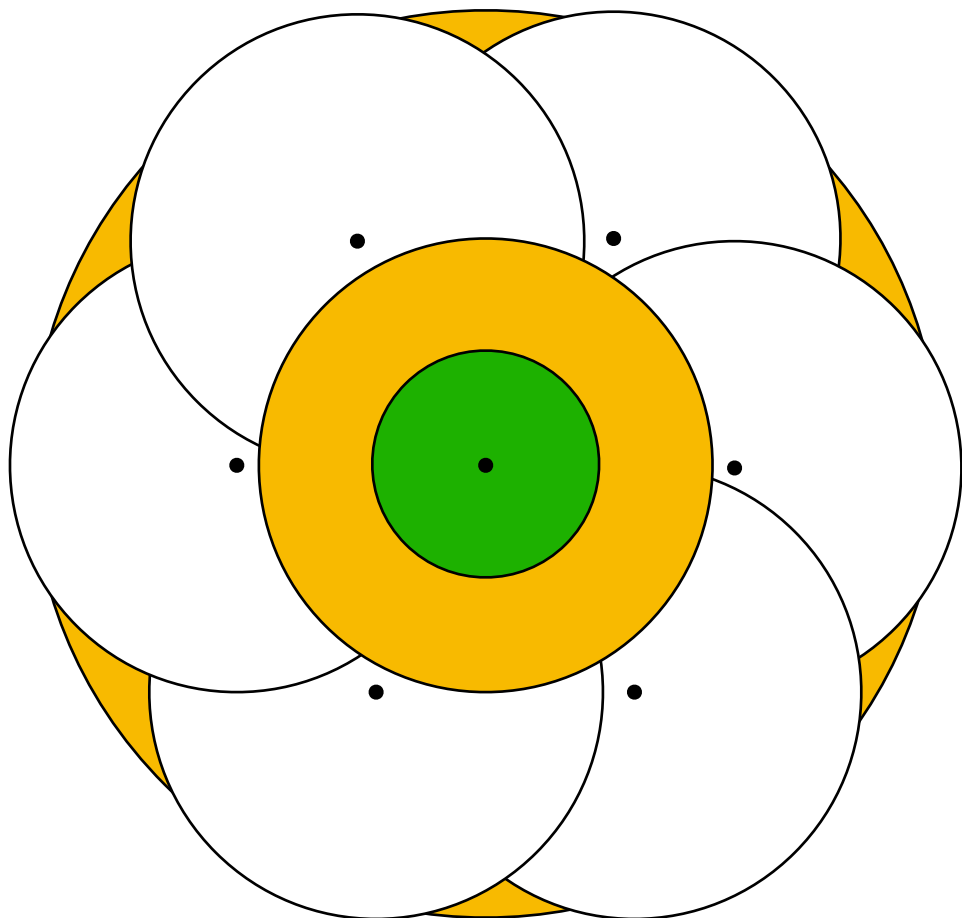

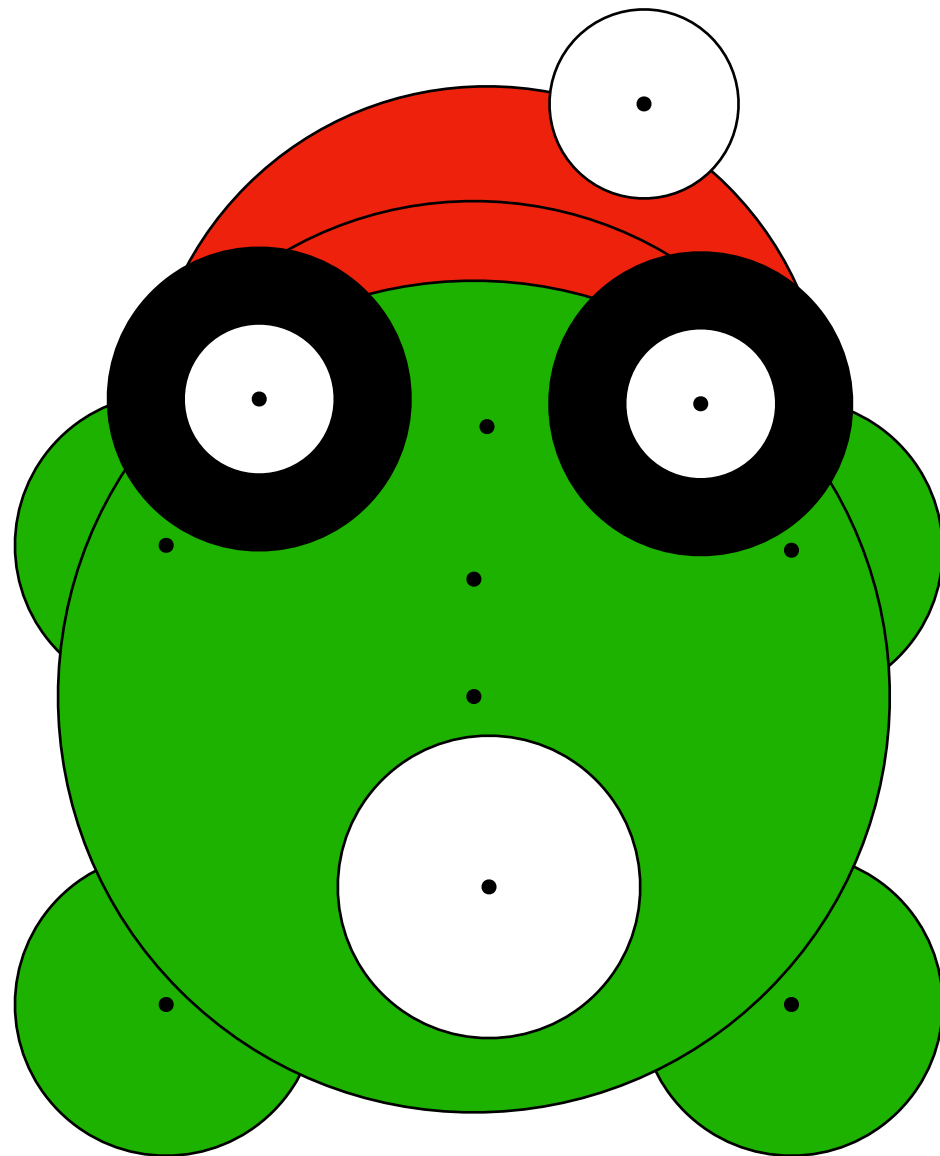
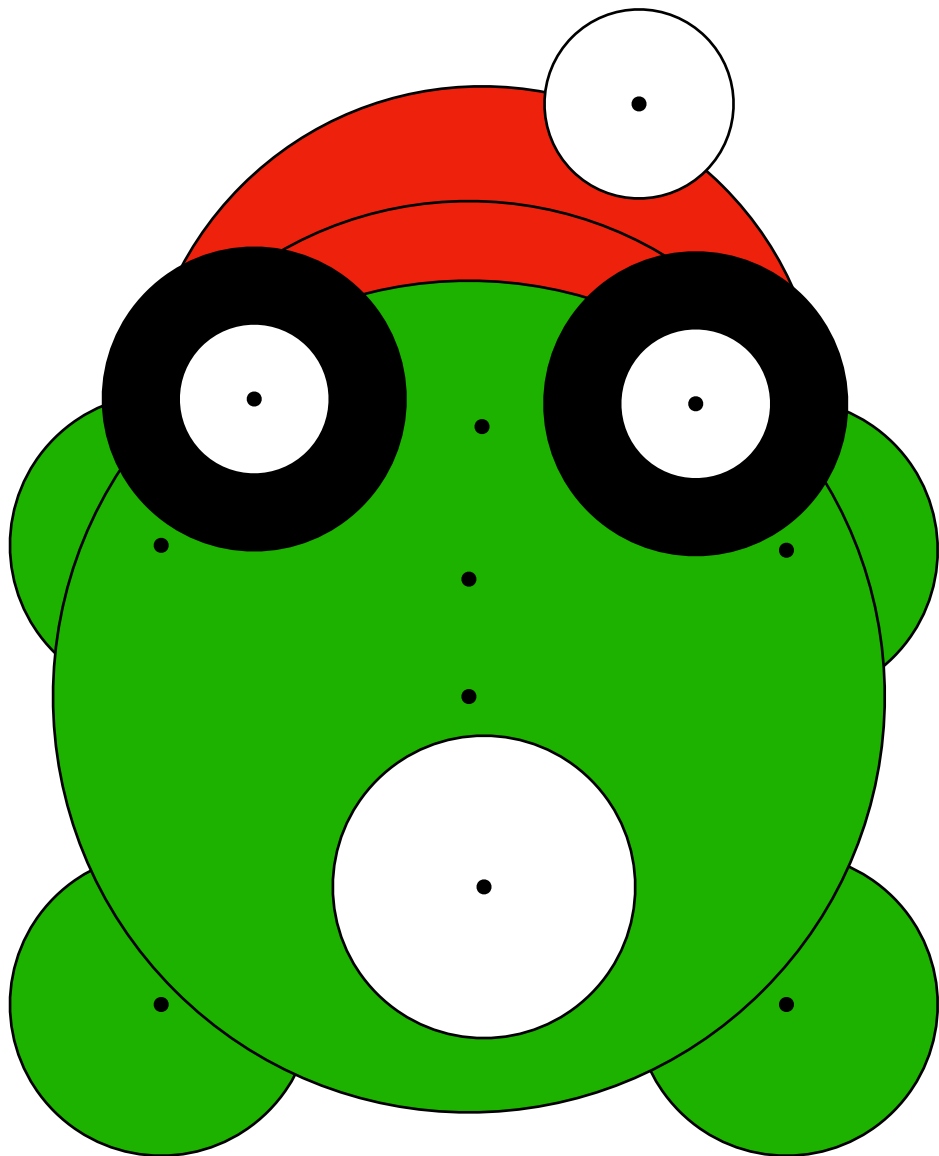

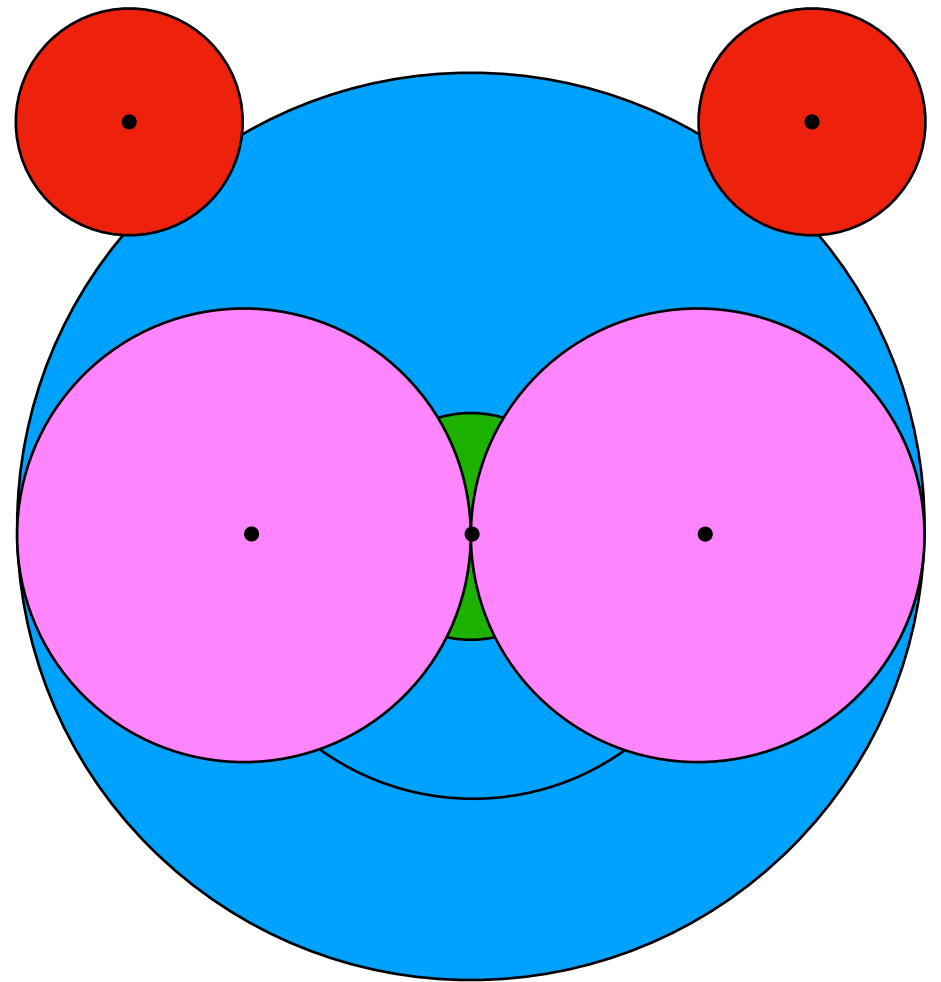
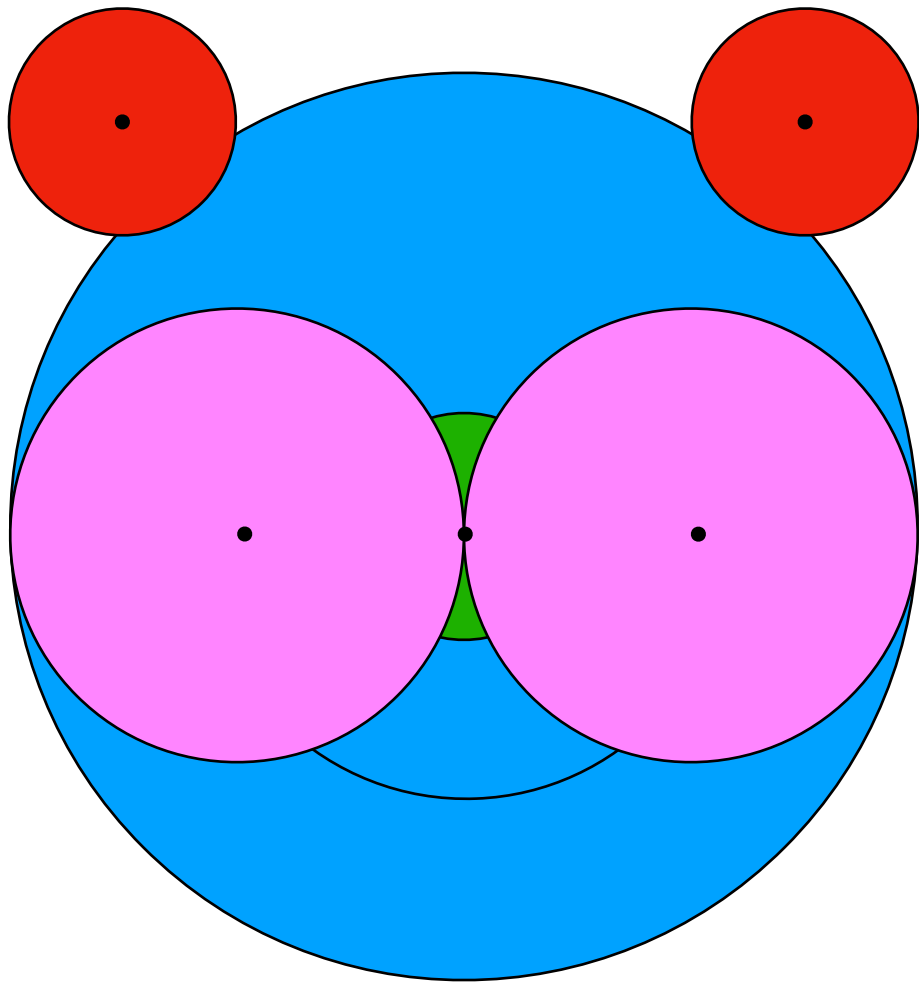

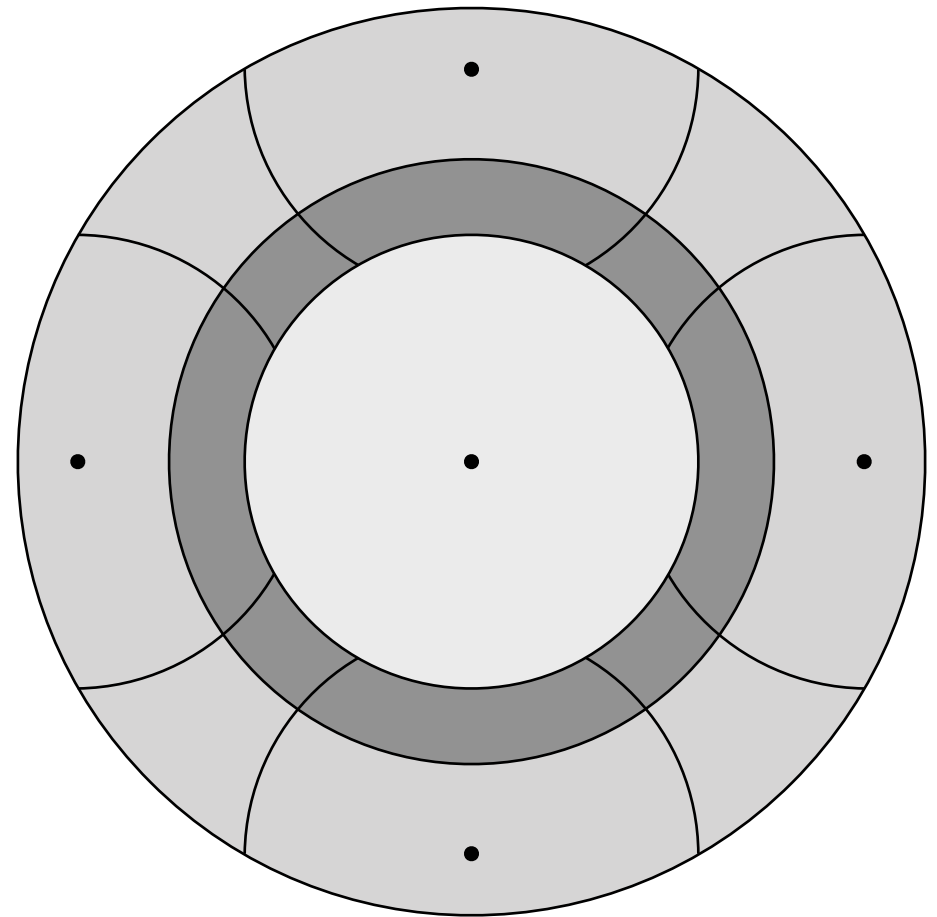
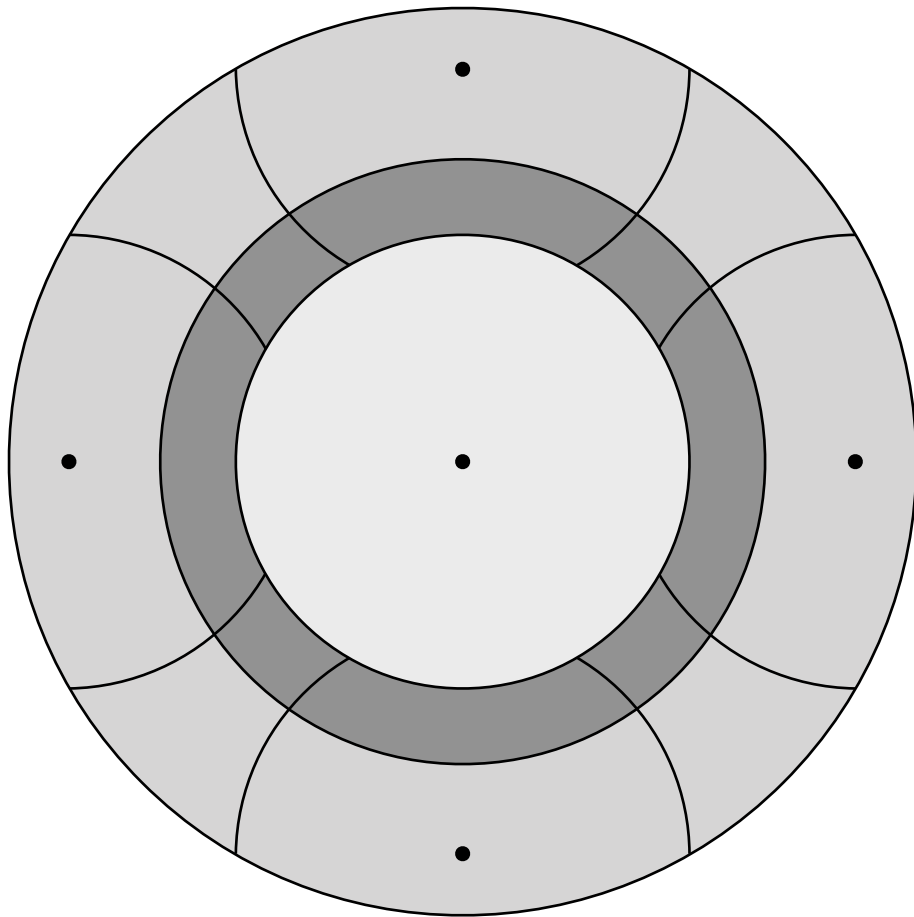

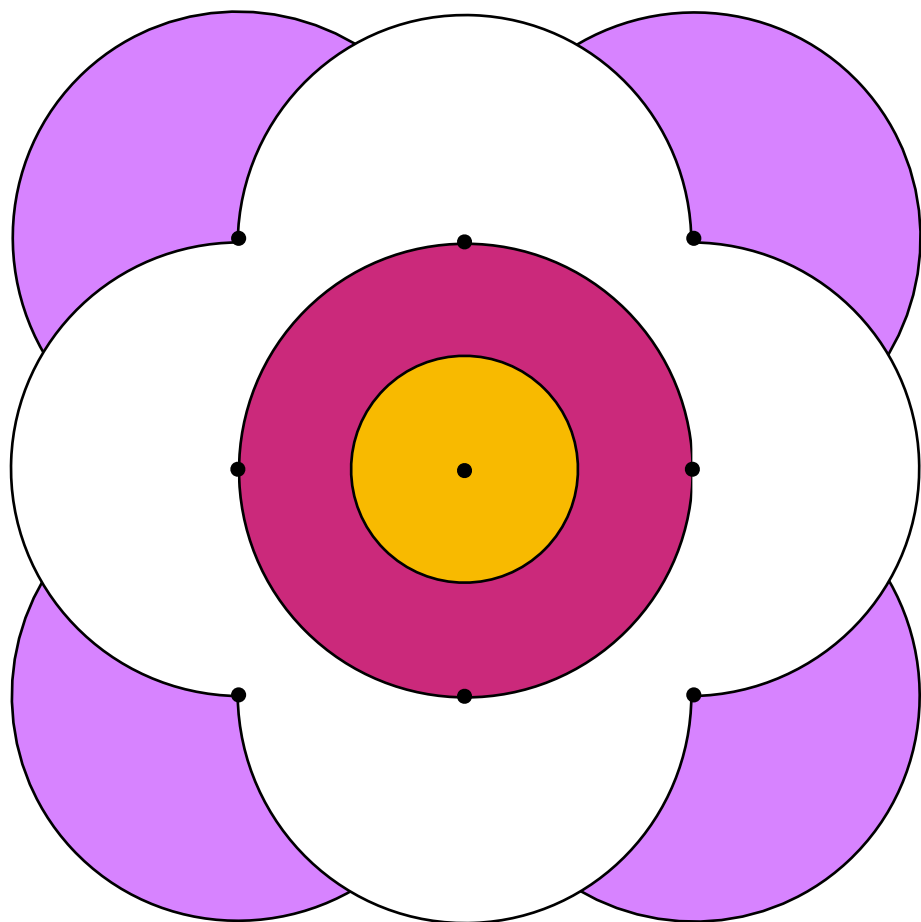
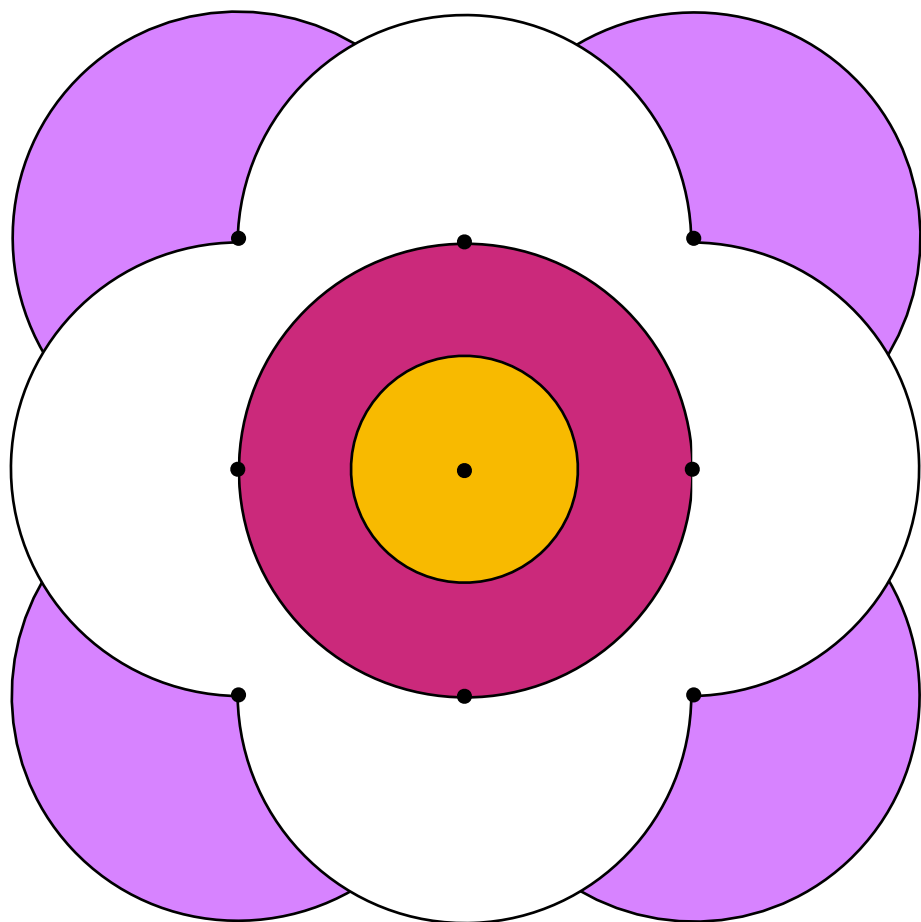

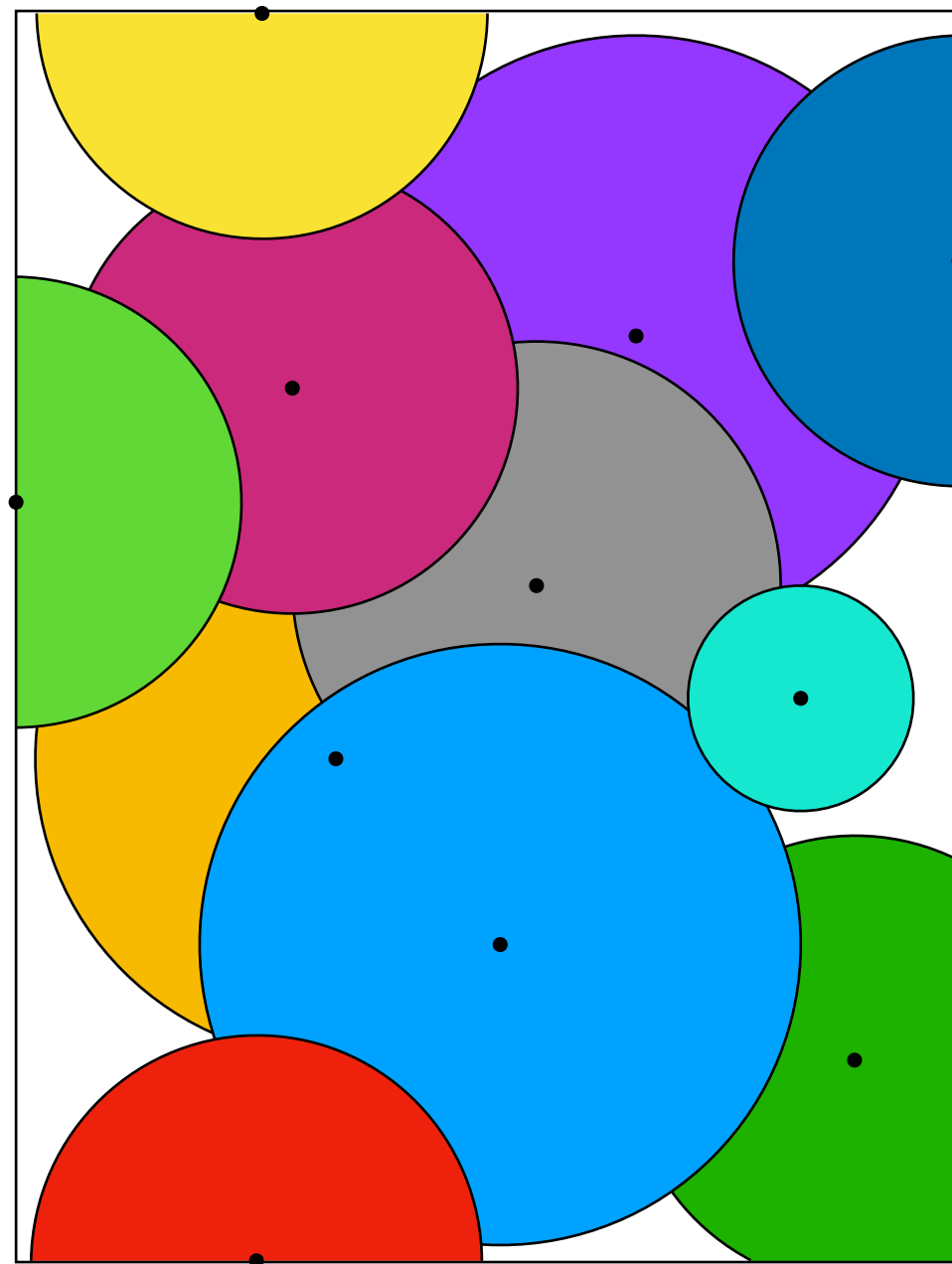
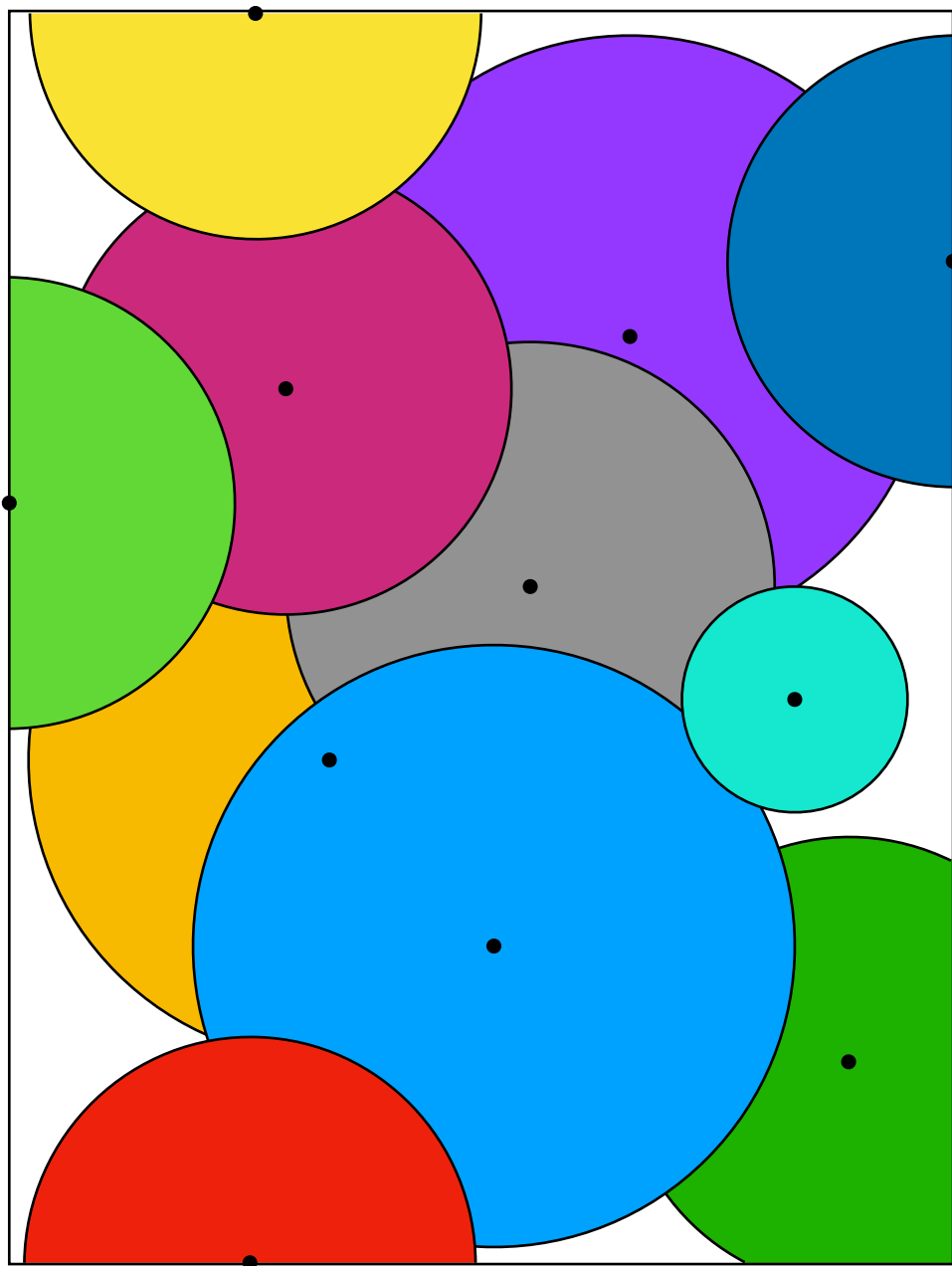

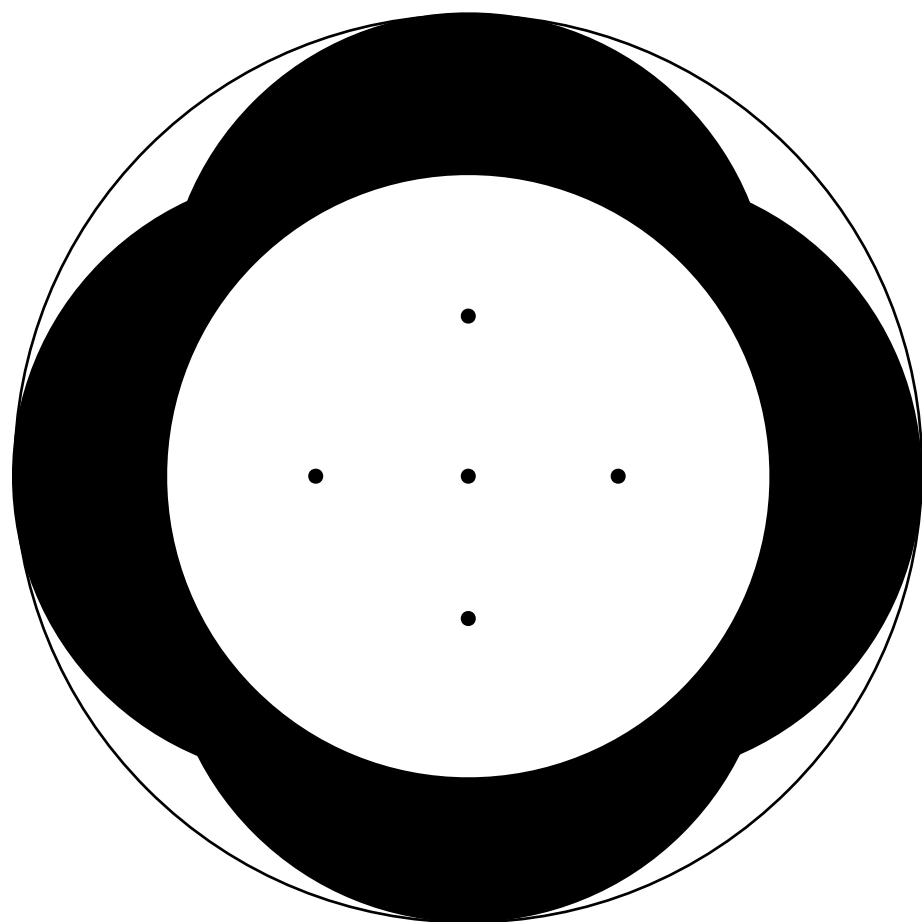
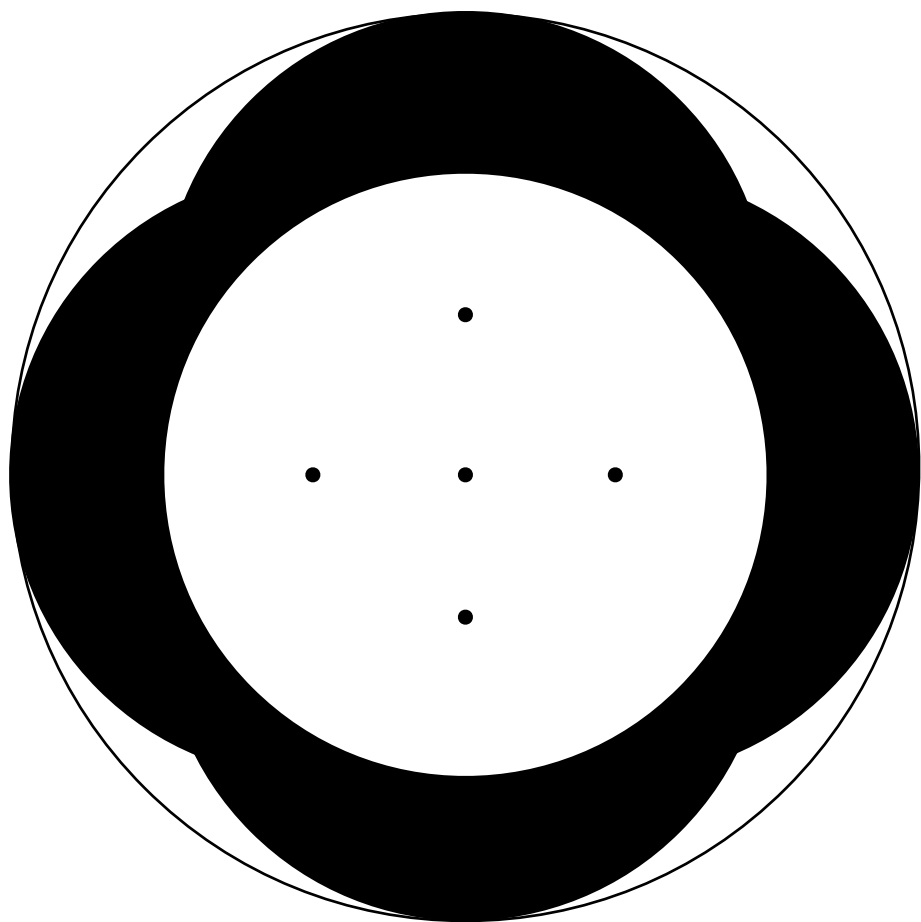

CIRCULUS

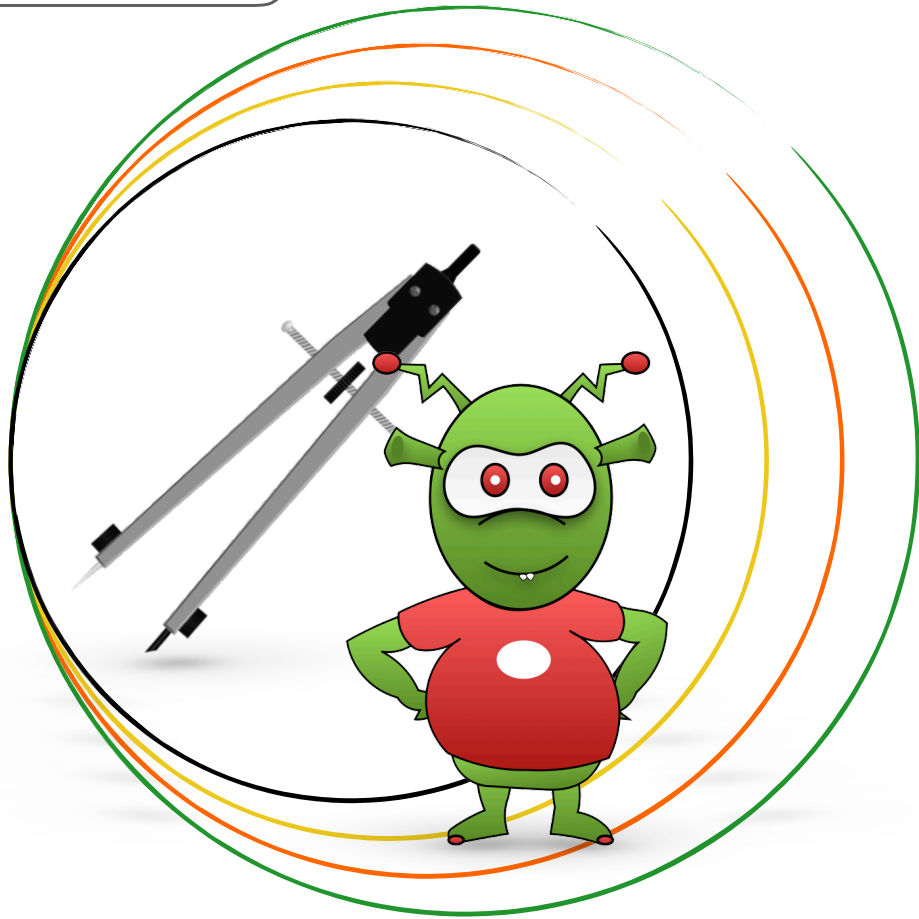

1	2	3	4	5	6	7	8	9	10	11	12	13	14	15	16
NIVEAU 1				NIVEAU 2				NIVEAU 3				NIVEAU 4			

CIRCULUS

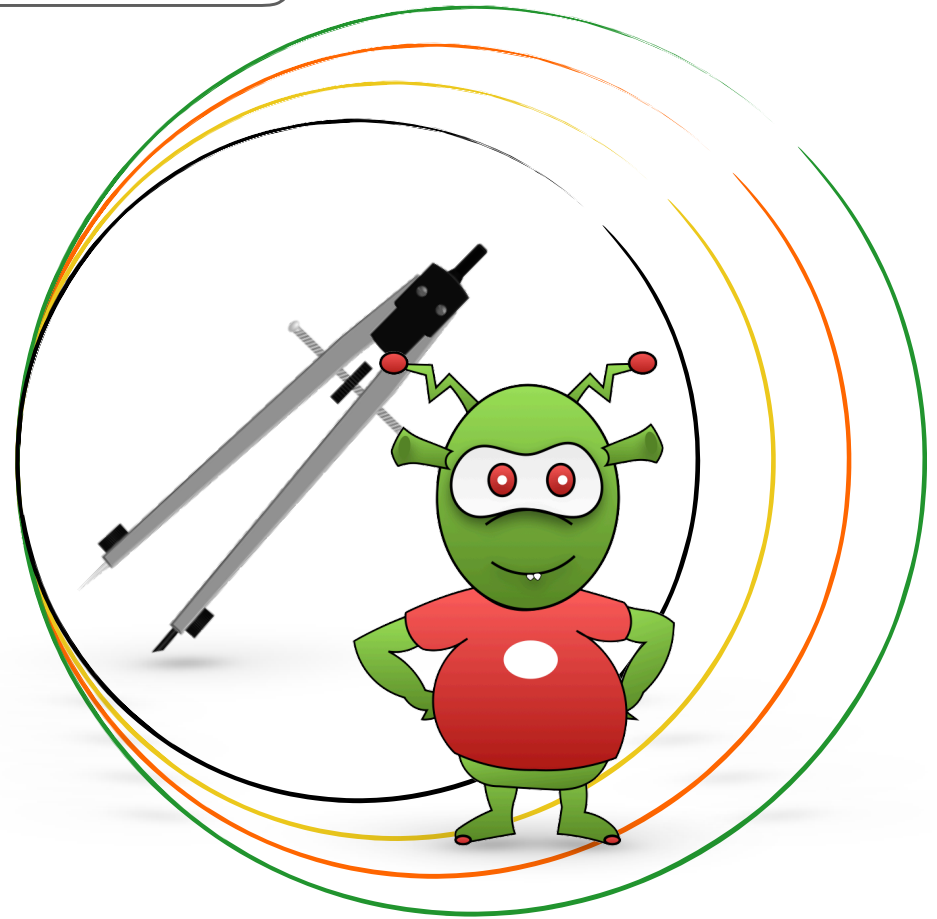

1	2	3	4	5	6	7	8	9	10	11	12	13	14	15	16
NIVEAU 1				NIVEAU 2				NIVEAU 3				NIVEAU 4			

CIRCULUS

1



CIRCULUS

1



CIRCULUS

2



CIRCULUS

2



•

•

•

•

•

•

•

•

CIRCULUS

5

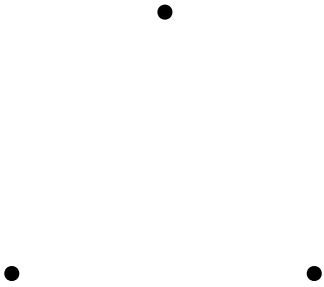

CIRCULUS

5

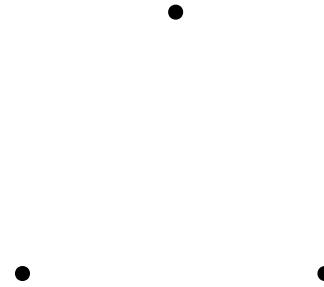

•
•

•
•

•
•
•

•
•
•

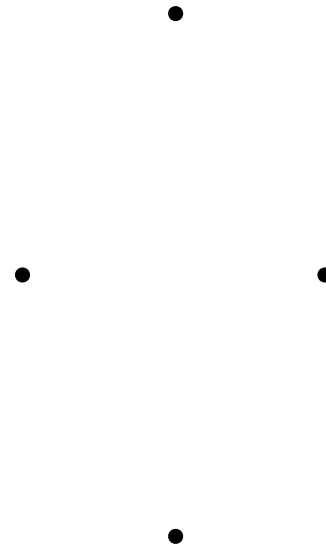
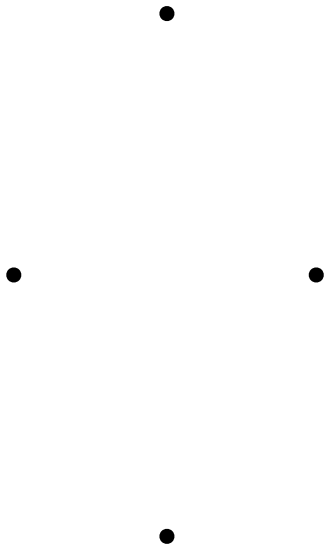

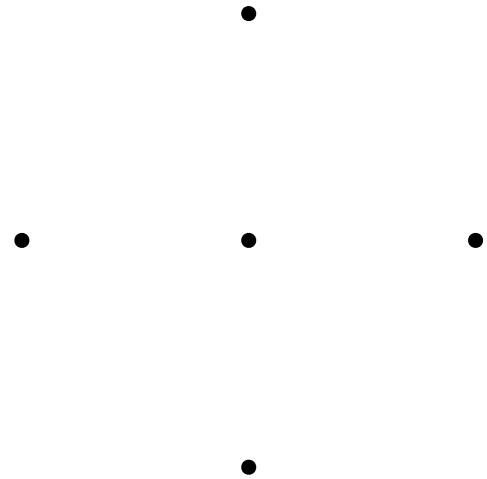
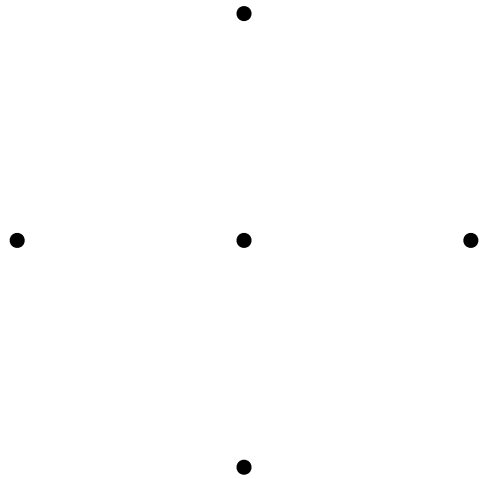

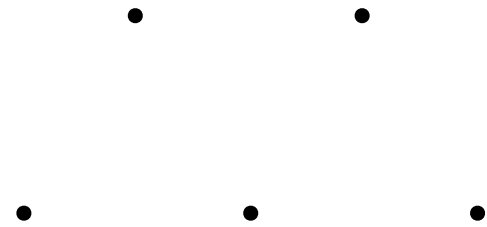
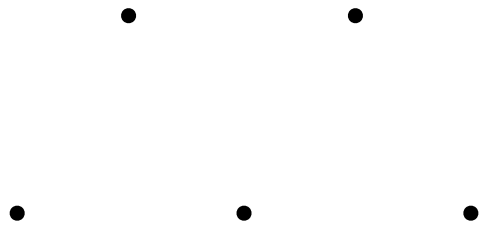



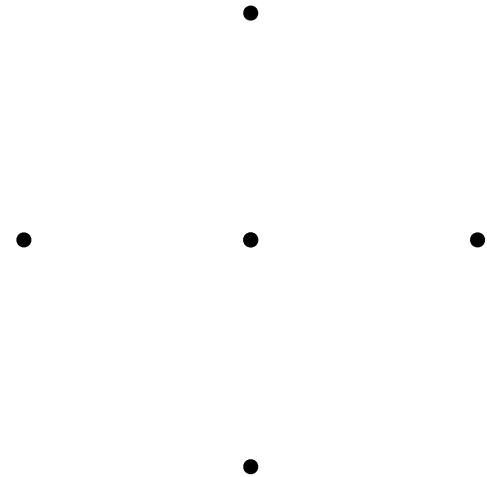
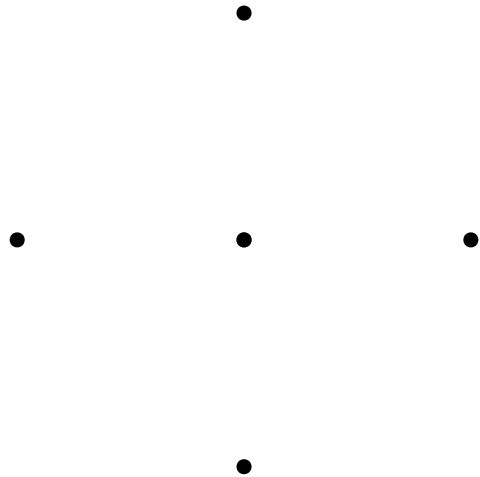

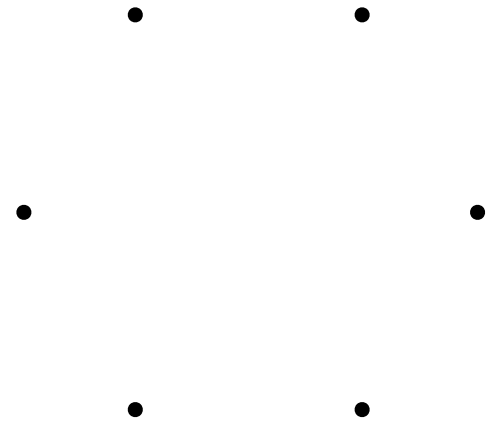
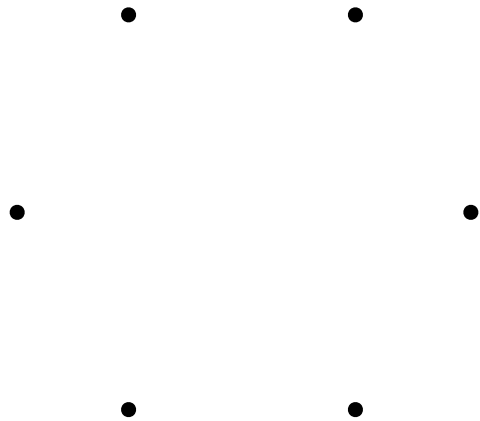

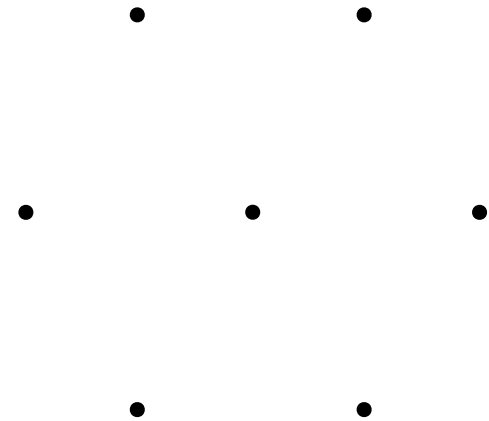
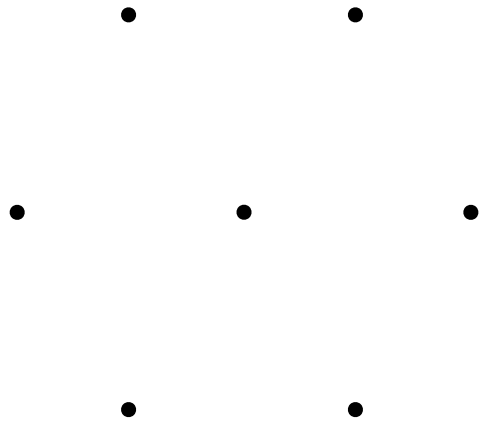

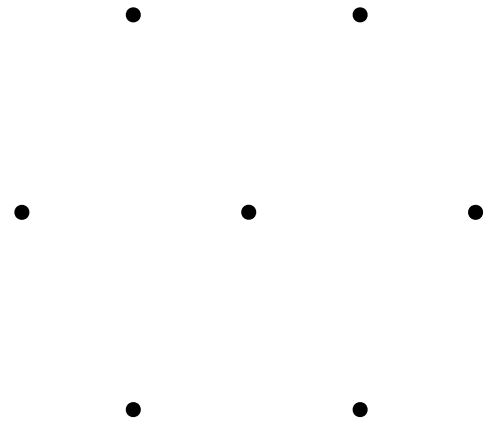
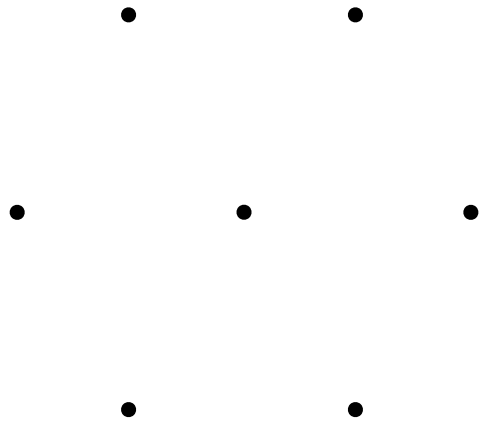

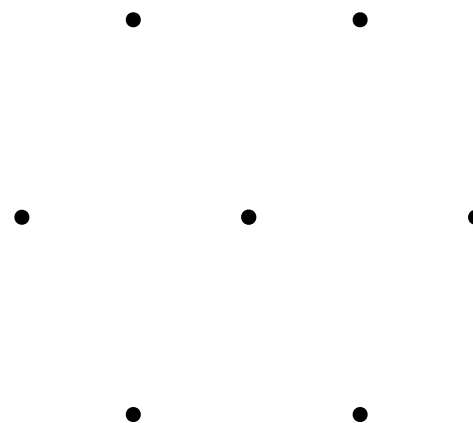
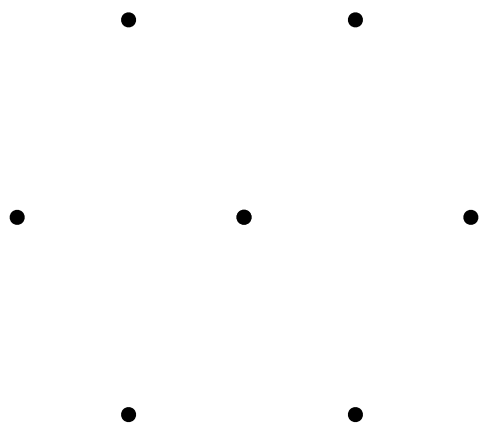

CIRCULUS

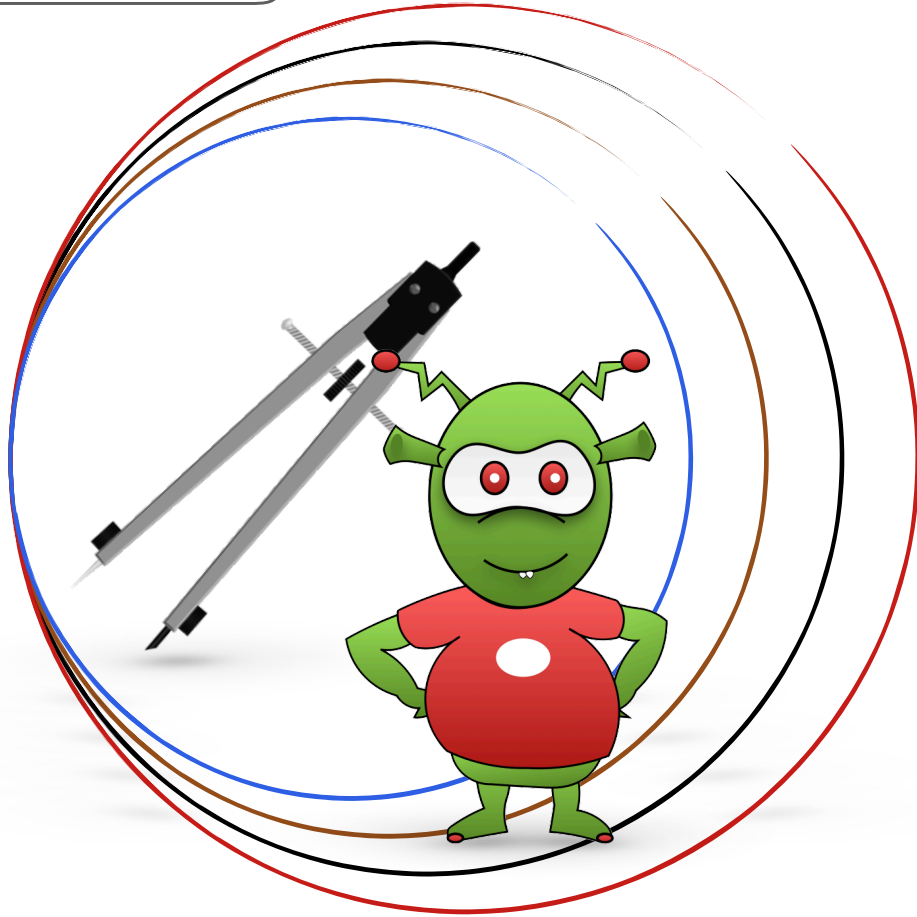

- 17
- 18
- 19
- 20
- 21
- 22
- 23
- 24
- 25
- 26
- 27
- 28
- 29
- 30
- 31
- 32

NIVEAU 5

NIVEAU 6

NIVEAU 7

NIVEAU 8

CIRCULUS

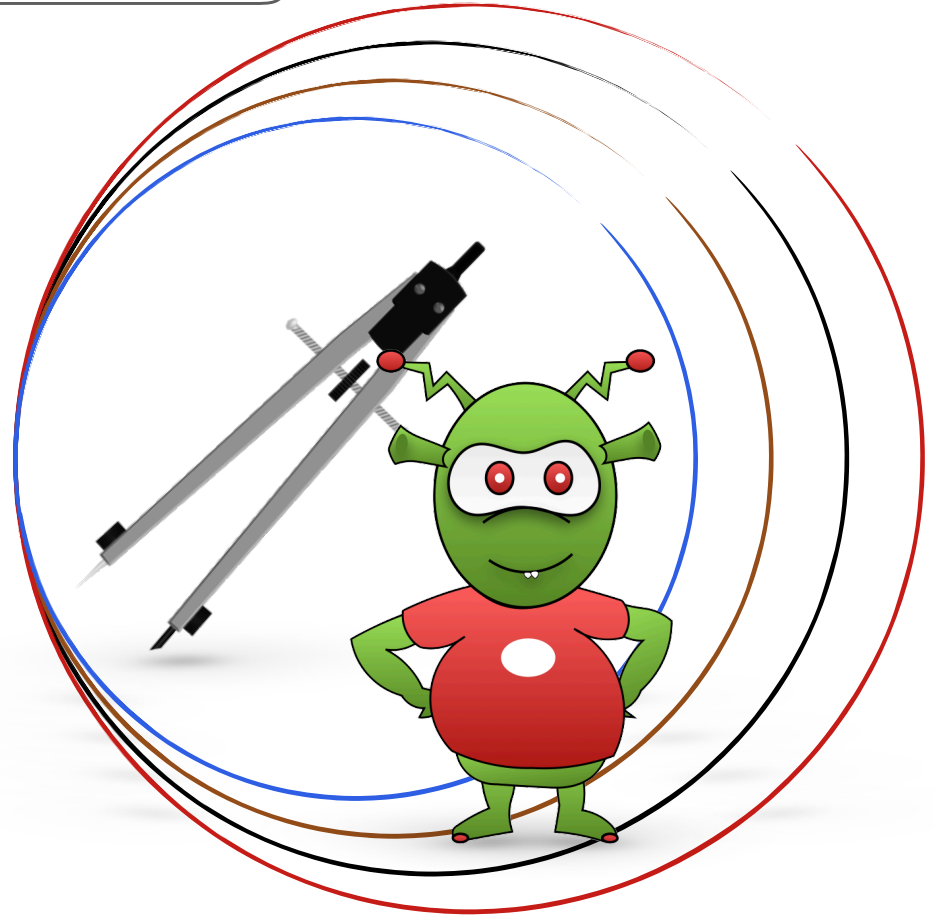

- 17
- 18
- 19
- 20
- 21
- 22
- 23
- 24
- 25
- 26
- 27
- 28
- 29
- 30
- 31
- 32

NIVEAU 5

NIVEAU 6

NIVEAU 7

NIVEAU 8

-
-
-
-
-

-
-
-
-
-

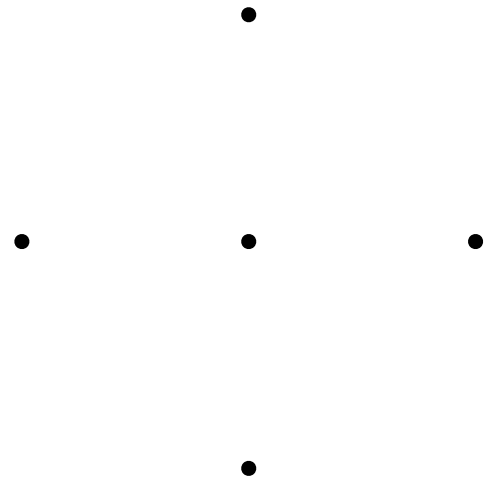
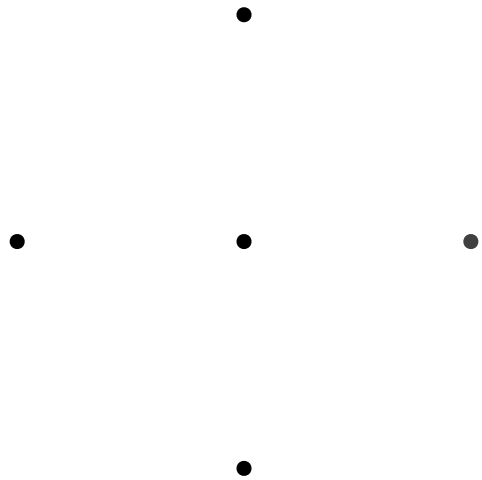

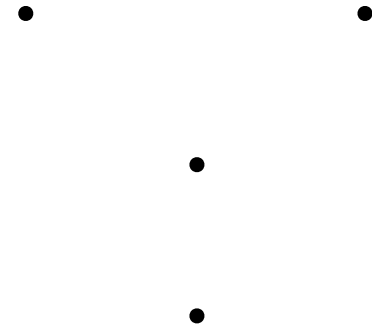
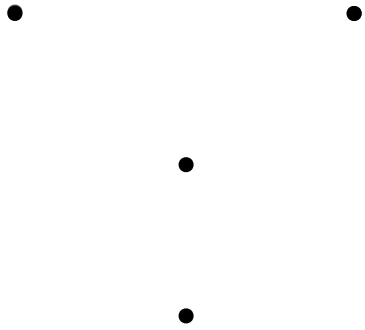

CIRCULUS

20

• • •

• • •

• • •

CIRCULUS

20

• • •

• • •

• • •

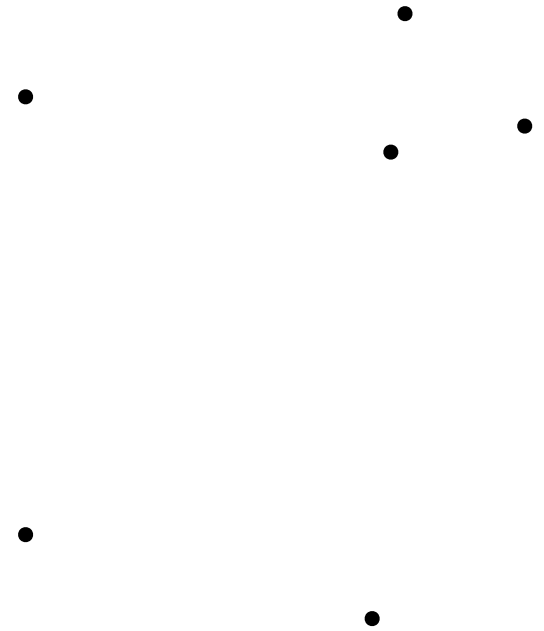
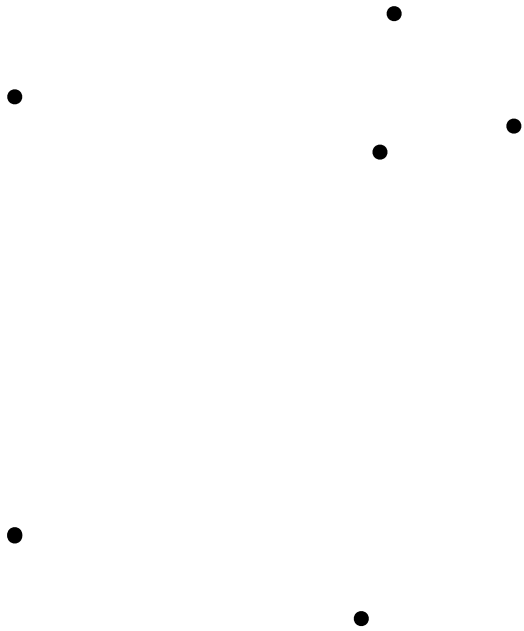

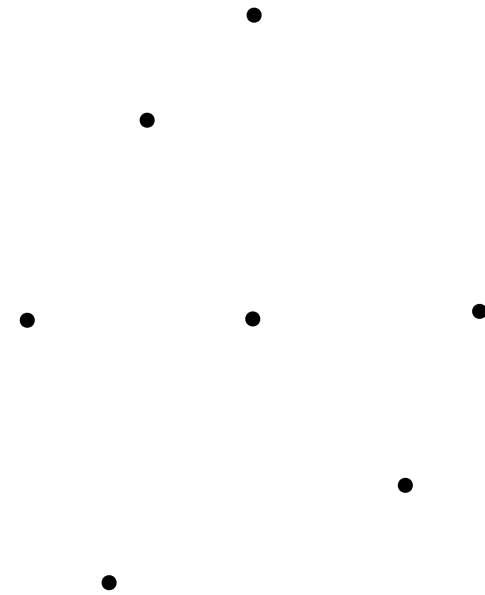
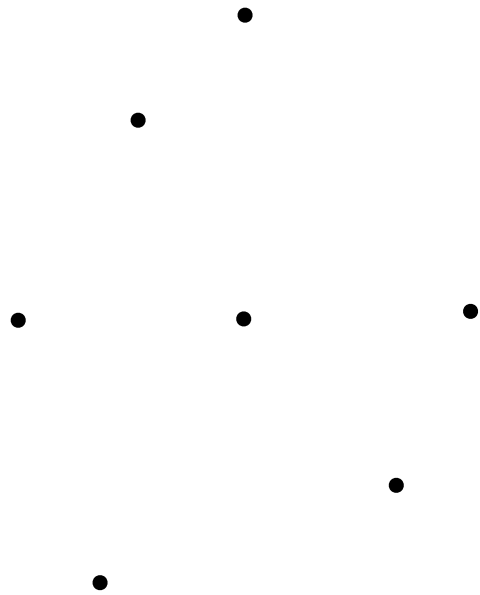

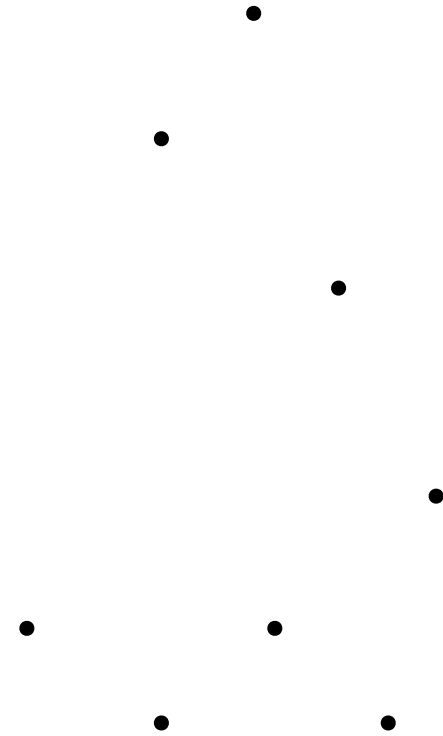
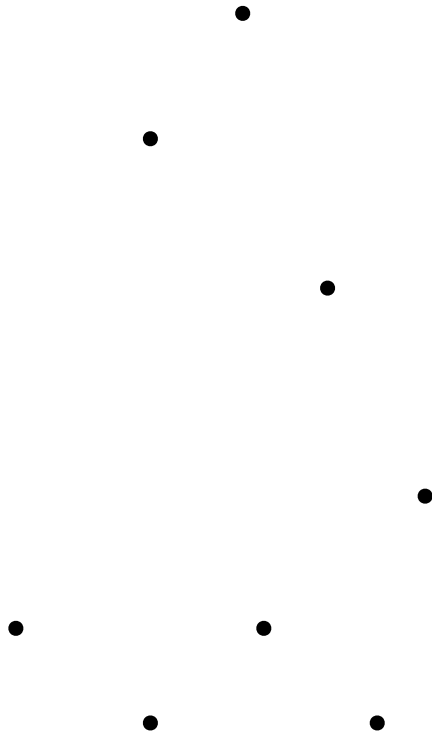

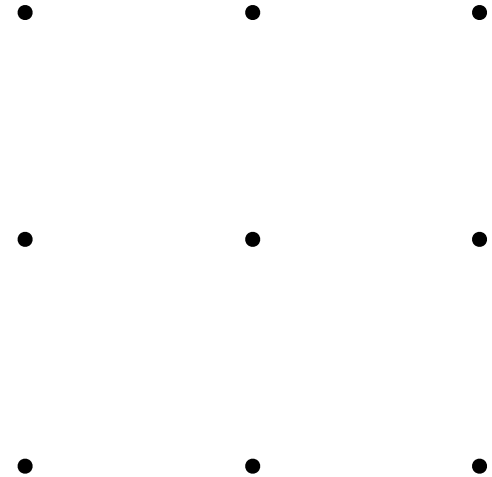
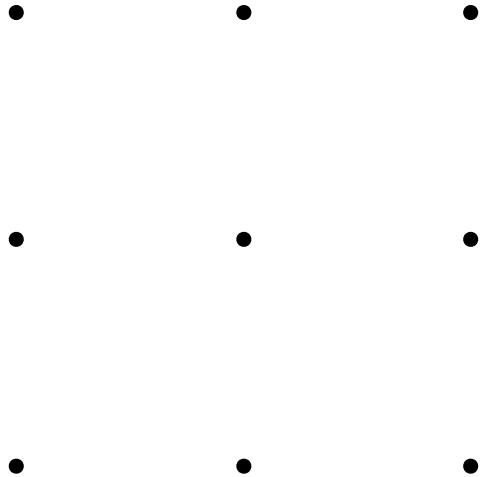

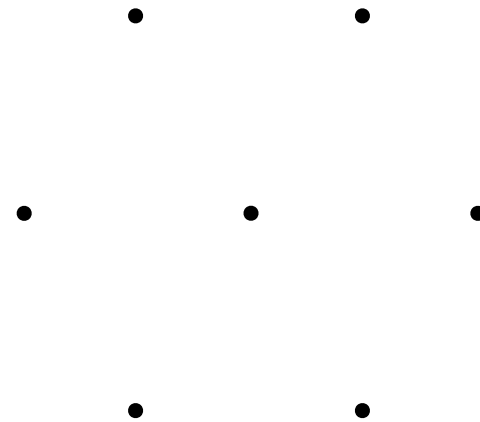
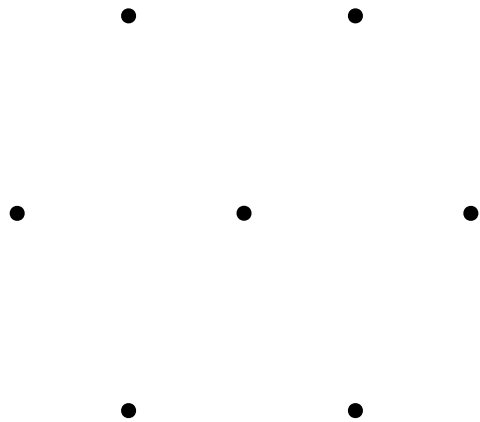

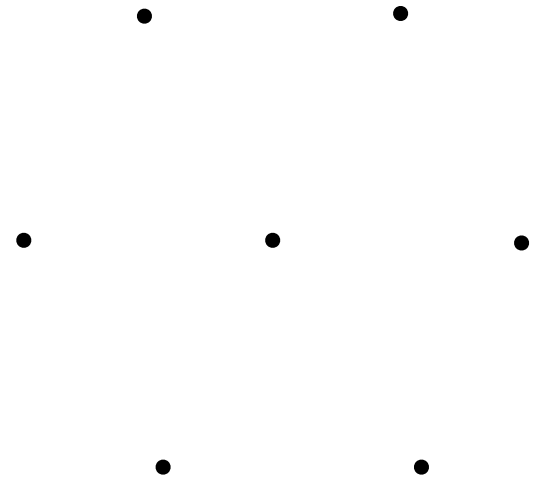
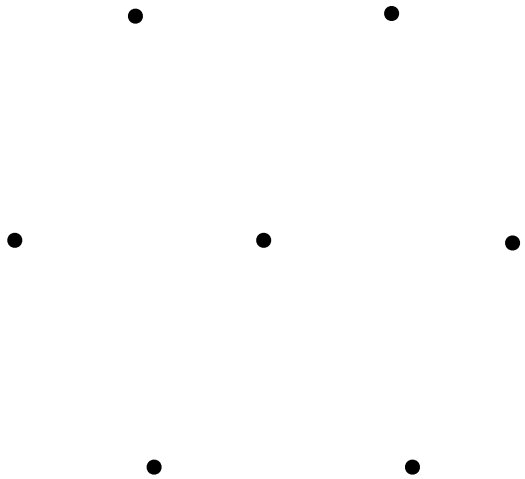

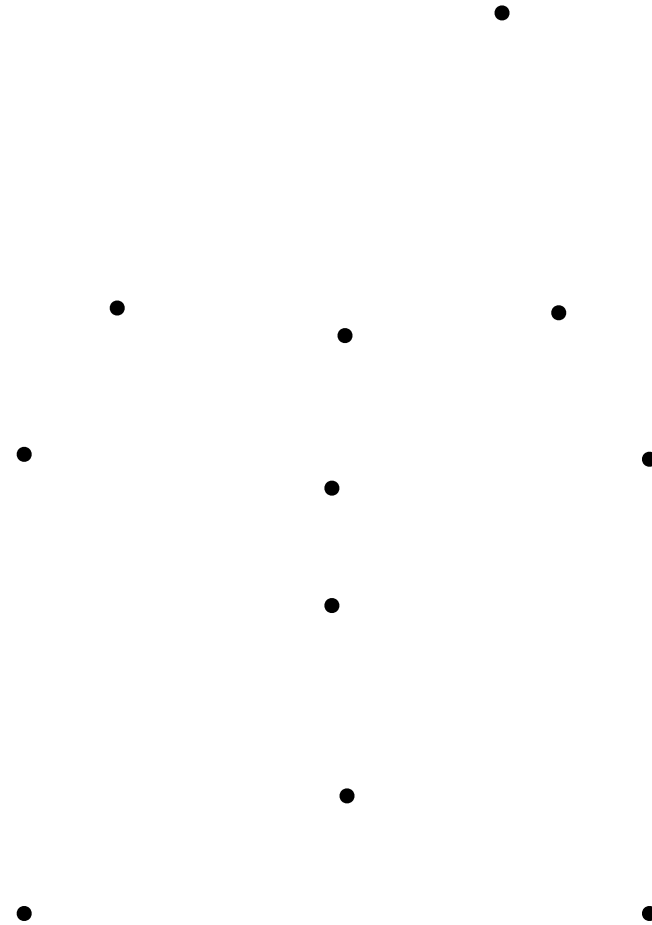
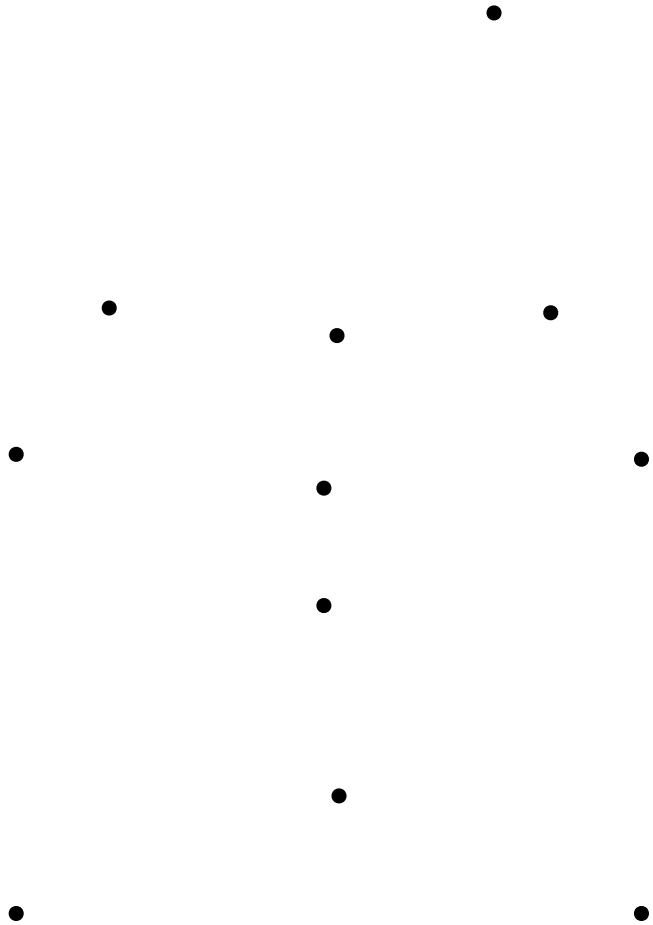



•

•

•

•

•

•

•

•

•

•

CIRCULUS

30

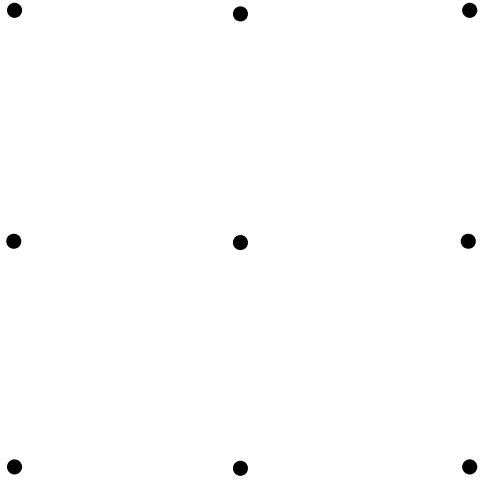

CIRCULUS

30

